

Software
Operations
Manual



System Requirements

PC with 1GHz or higher, Intel® Pentium® Processor or compatible
Microsoft® Windows XP Professional or Vista Business Edition
Microsoft® .NET framework 2.0
256 MB of RAM minimum
1 GB of available hard-disk space for applications and database
1 Serial communications port
RS-485 Interface Module (supplied by BinMaster)
RS-232 Serial Cable (supplied with interface module)
SmartBob Remote Units

1.0 Introduction

The BinMaster eBob Software is designed to intelligently manage inventory in up to 100 vessels working with the BinMaster SmartBob2 Remote level sensors. The software (Figure 1) provides graphical representation of:

- Distance to and of product
- Volume of product and headroom
- Weight of product and headroom
- Percent full
- Date and time of last measurement
- Vessel name and content
- Vessel Status Enabled/Disabled
- Measure button and headroom checkbox

Advanced control functions are also available to set alarm points, schedule measurements, build common group measurements and automatically email information to appropriate users.

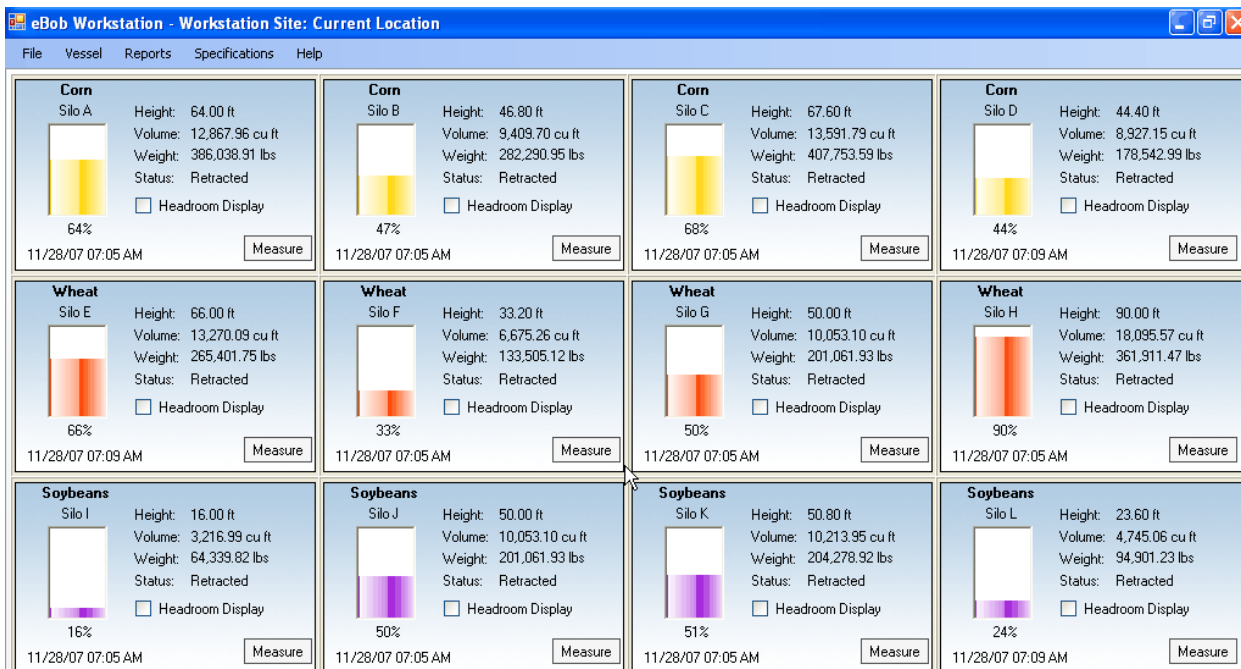

Figure 1

BinMaster eBob V5 Software consists of three software components which work together to provide setup, control and data reporting of measurements obtained by the SmartBob2 Sensor. The three major system components are:

- 1. eBob “Workstation” V5 User Interface** Graphical user interface with vessel display, control and setup screens for system configuration.
- 2. eBob Measurement and Scheduler Services** Windows Service executables manage control, communication and task scheduling for automated measurements and data transfer.
- 3. eBob SQL Database** SQL database records all measurement history for reporting from eBob Workstation or any SQL query engine. Microsoft SQL Server Express and Crystal Reports are included in package and installed on the host PC.

1.1 eBob Workstation Installation

1.2 Pre-Installation Considerations

Note: eBob Workstation requires Microsoft® .NET framework 2.0 is installed before eBob installation. See Section 7.1 for considerations for upgrading from previous IMS or eBob Versions.

1.3 Easy Installation

See section 1.1 Quick Start Guide for a list of Easy installation steps.

1.4 Quick Start Guide

1. Review eBob system requirements at the beginning of this manual and verify the intended PC can support the eBob V5 software and Microsoft® SQL Server Express.
2. Install eBob Workstation using the “Easy” install option (Figure 2). Follow the on-screen prompts as the installer automatically installs and configures the application components for initial use.

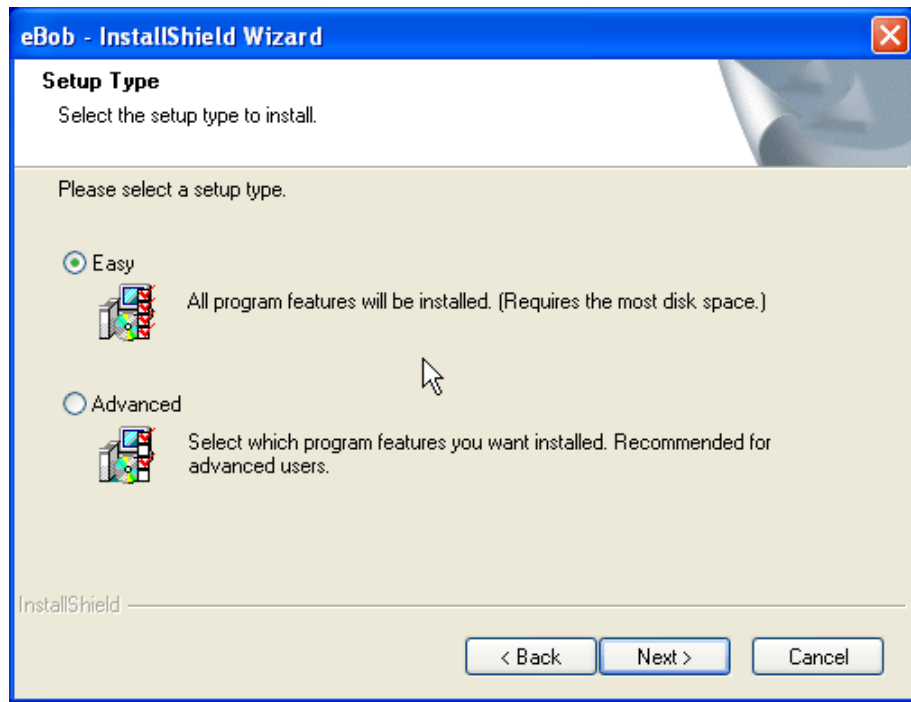

Figure 2

3. Open eBob Version 5 by clicking Start | Programs | eBob | eBob Workstation. The user interface will open showing a splash screen, then the main user interface without any Vessel / SmartBob sensors configured.

4. Create the vessels in your system by clicking Vessel | Vessel Maintenance | Add New button (Figure 3). In the Vessel Maintenance screens (Figure 4), enter information into the following fields, *at a minimum*:

- Vessel Name (Configuration tab)
- Vessel Type (Configuration tab)
- Vessel Size (Configuration tab)
- Vessel Contents (Configuration tab)
- SmartBob device **type** (Device tab)
 - Selects communication protocol, “A” or “B”
- SmartBob device **address** (Device tab)

Note: Save and Close the Vessel Maintenance screen when done.

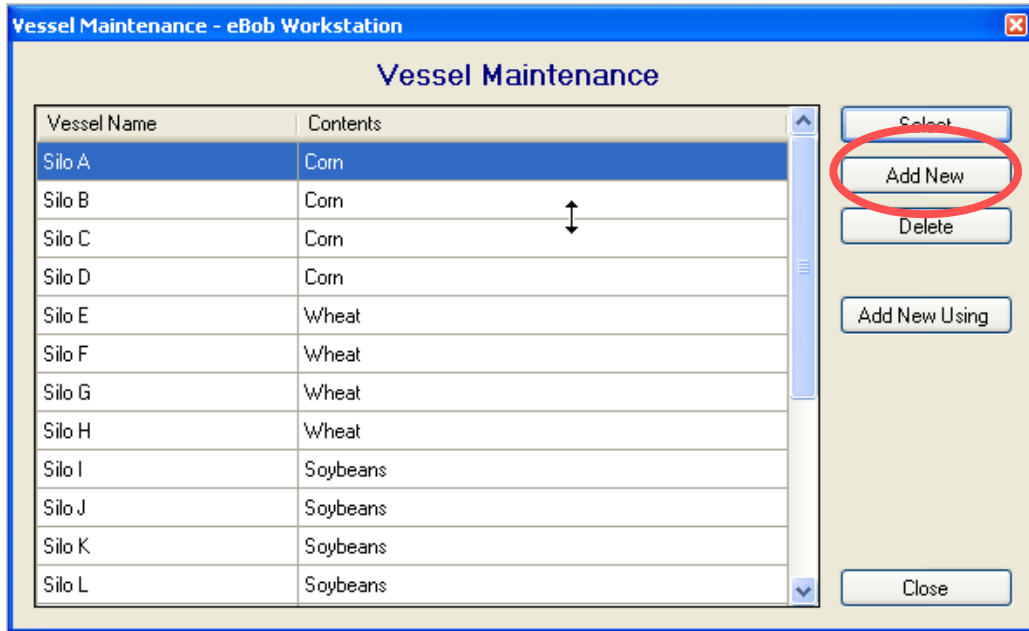

Figure 3

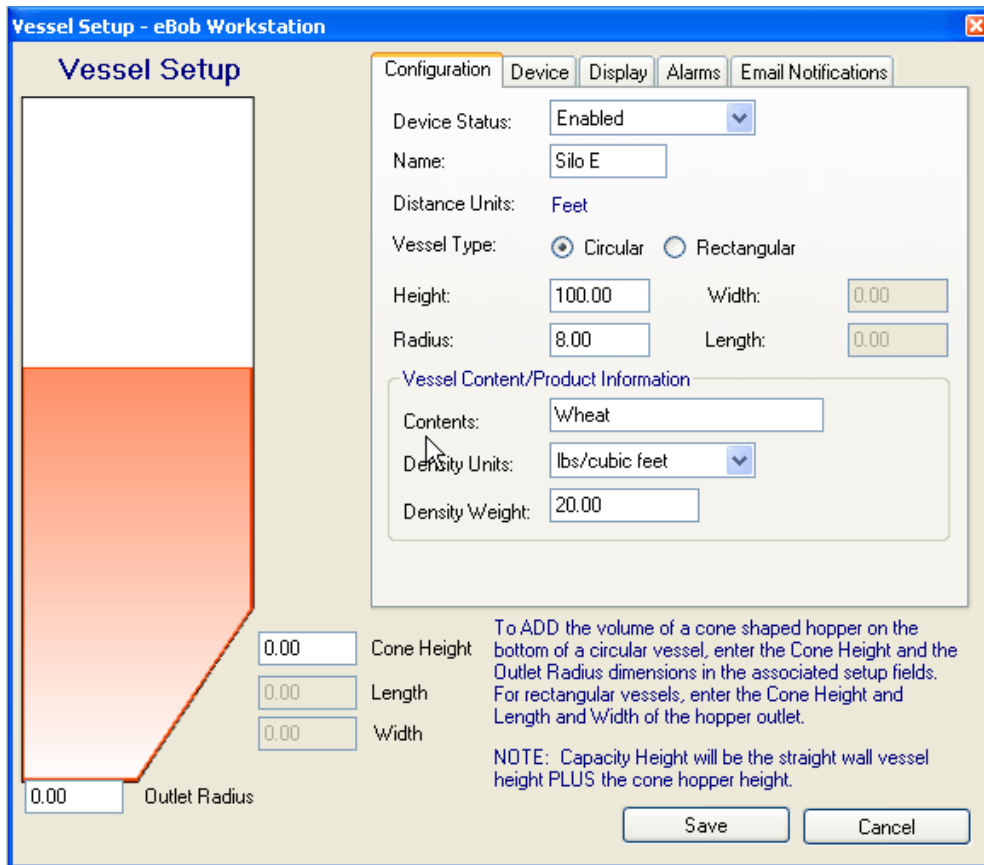

Figure 4

5. Select the serial communication port the PC is using to communicate with the Smart Bob sensors (Figure 5). The Communications Port setting is located in the Specification | Workstation Site Setup menu.

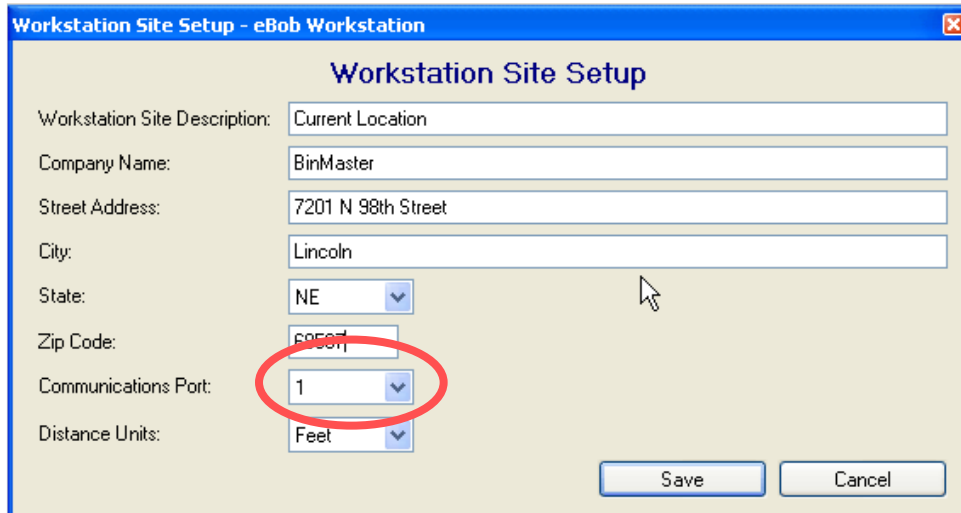

Figure 5

6. Measure vessels by using the Measure button (Figure 6) on the main vessel display or measure all of the vessels in the system using the Vessel | Measure All menu item.

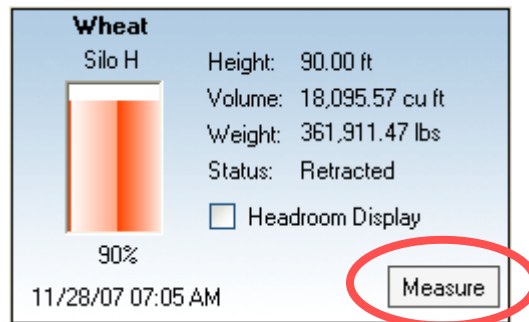

Figure 6

7. Verify the results of the measurements by examining the product height, volume and weight, if configured, against known values or estimates.

2.0 System Configuration

2.1 Pre-Configuration considerations

It is important to plan and gather information about the sensor network prior to installing the software and attempting to take measurements. A little planning up front will likely save headaches when starting up a new system.

Important information to gather about the SmartBob system:

Vessel / System Information

- Vessel type, rectangular or circular
- Dimensions
- SmartBob sensor address
- PC Communication port number
- User information (if login will be required)

Product information

- Product name
- Product density weight (for accurate weight measurements)

Email Reporting

- SMTP server name, port number and authentication details
- Contact list with email addresses.

3.2 User Interface

3.2.1 File Menu

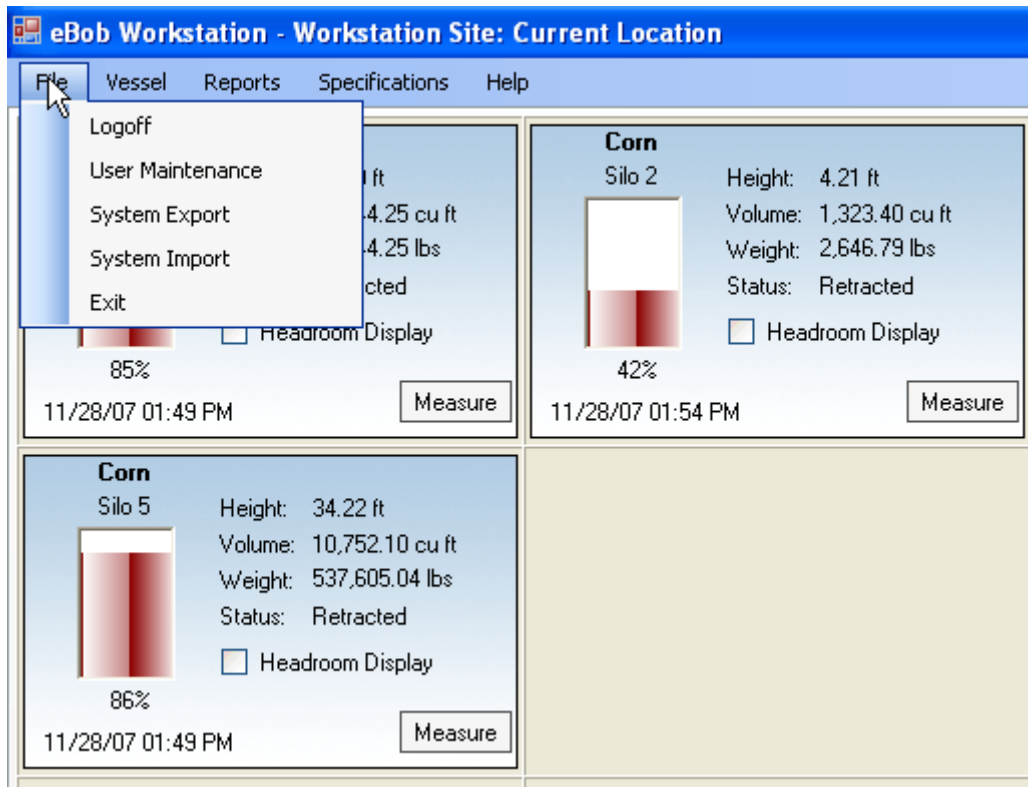

Figure 7

Logoff / Login Logs on and off users whom have been created in User Maintenance menu. Login is not required if the “Do not require login” is checked in the Specification | System Setup dialog box.

Note: Not requiring a login is non-secure, anyone who opens the application will have admin rights by default.

User Maintenance Creates users and sets permissions level for different system users. Add a new user by clicking Add New (Figure 8). Select an existing user by clicking and highlighting the user in the list and clicking Select, or double click the user in the list to bring up the User Setup screen.

Note: The Admin user is created by default. This user cannot be deleted, but the password may be changed. The default password is “1234”.

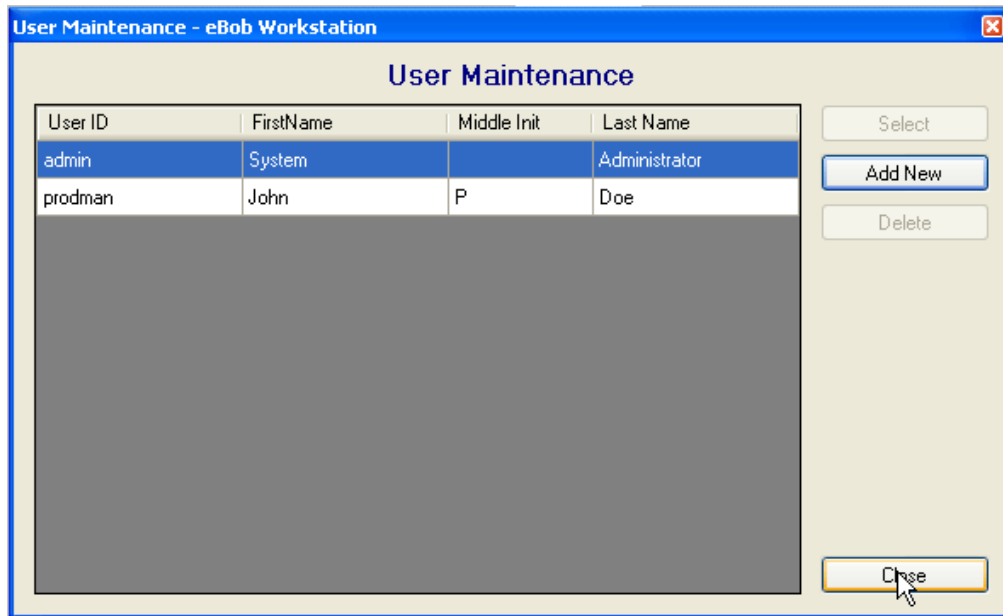

Figure 8

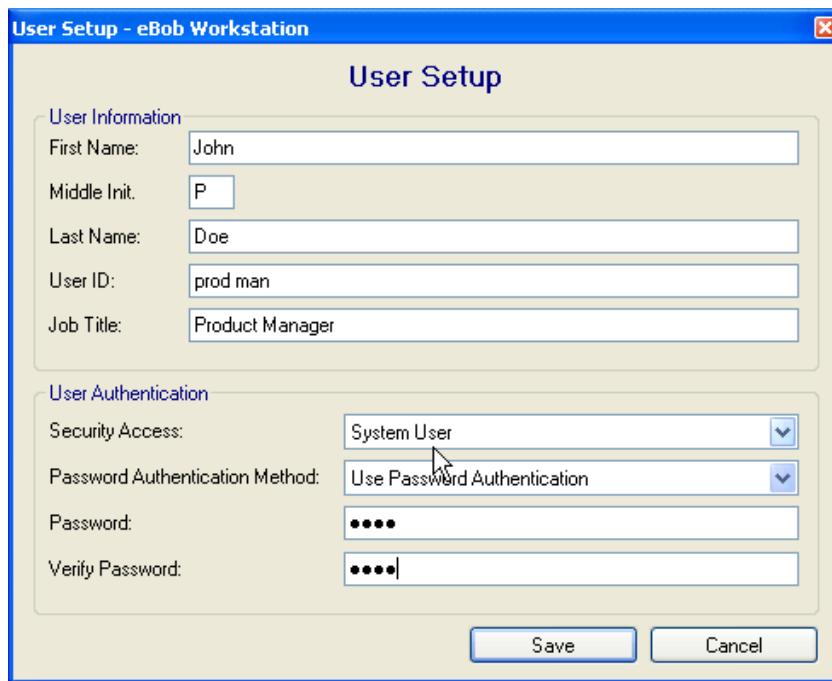

Figure 9

User Setup (Figures 9 and 10) There are three user types available.

- **Admin** Full access to all features and configuration screens
- **System User** Full access to measurement control and vessel setup, no system configuration access.
- **Read Only** Access to measurement data only, no configuration access

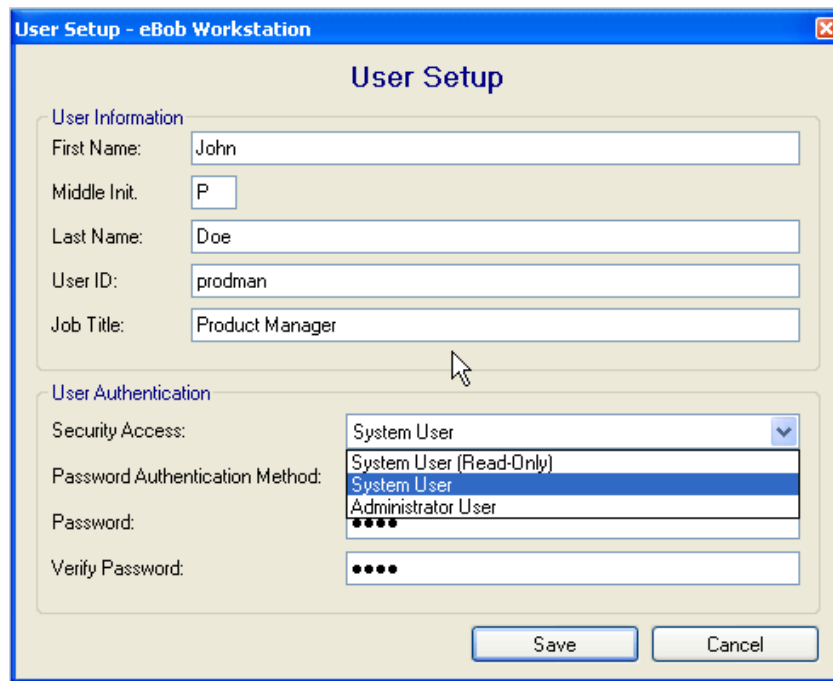

Figure 10

System Export System import / export tools are useful for backing up a system setup for archiving or transferring a system setup to another installation. The System Export Tool creates a system data file (Figure 11) which contains all the setup and configuration data of the SmartBob / Vessel system, plus the last 10 measurement records of each vessel.

Tip: The System Export is very useful for troubleshooting or answering setup questions. The system can be exported and emailed to BinMaster Technical Support for review or troubleshooting.

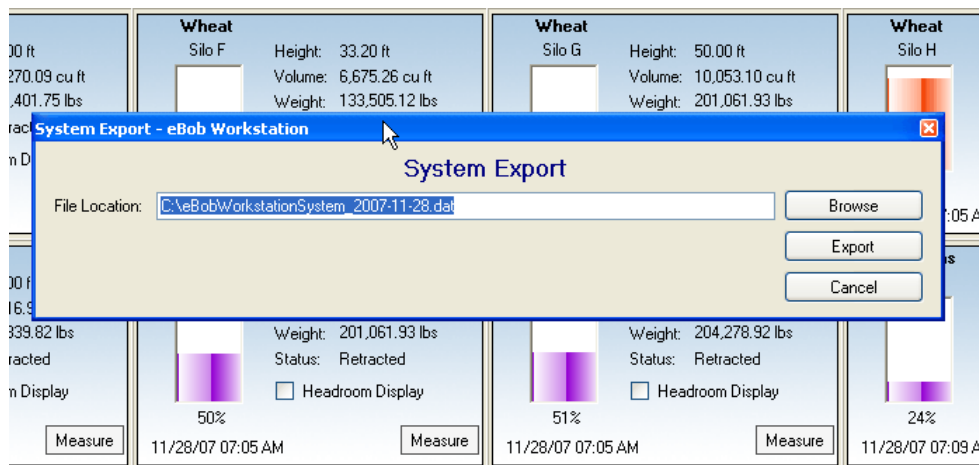

Figure 11

System Import The System Import tool imports an exported eBob V5 system data file. An exported system configuration file contains all of the setup information and the last 10 measurement records.

Note: When a system is imported, all existing configuration data is overwritten with the system parameters from the imported file.

Exit Closes the eBob V5 User Interface.

Note: When the eBob Workstation user interface is closed, the eBob V5 Measurement Engine and Scheduler Services will continue to run as Windows processes. This allows measurement schedules to execute without the eBob user interface open or if different Windows users login to the PC controlling the SmartBob network. See Section 4.0 Windows Services for information on managing windows services.

3.2.2 Vessel Menu The Vessel Menu (Figure 12) is the main configuration and control interface for the actual SmartBob sensors and the vessel configuration parameters. Five menu items allow access to the different configuration screens.

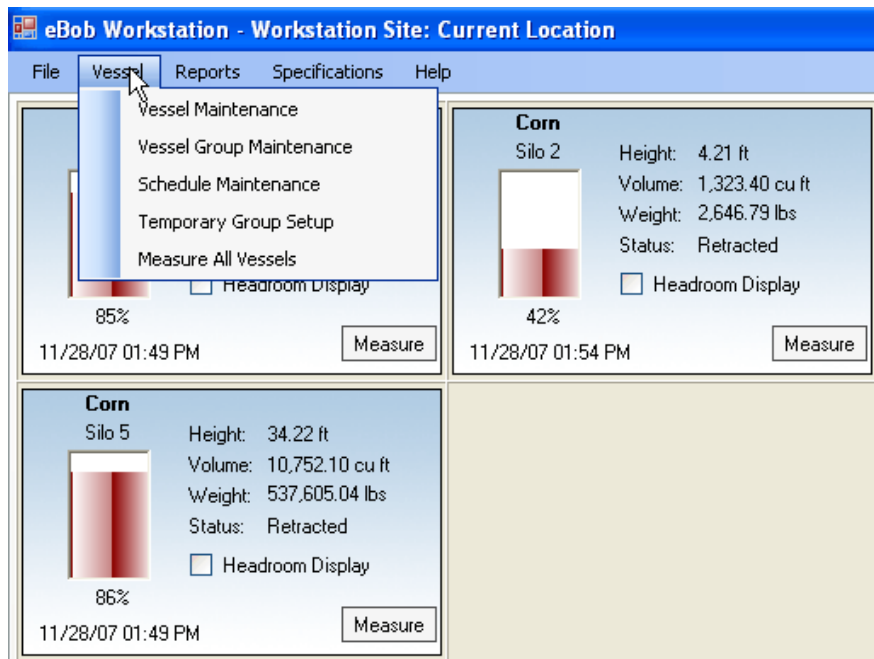

Figure 12

Vessel Maintenance Creates and configures the vessel associated with the individual SmartBob sensors in the system (Figure 13). The Vessel Maintenance screen has the following components and controls:

- **Vessel list** A list of currently configured vessels in the system. Highlight the desired vessel in the list and press Select or double click the vessel in the list to open the Vessel Setup menu.
- **Select button** Selects the highlighted vessel and opens the Vessel Setup screen.
- **Add New button** Opens the Vessel Setup screen with a new, blank vessel.
- **Delete button** Deletes the highlighted vessel from the system.

Note: All history associated with a deleted vessel will remain in the history database

- **Add New Using** Copies an existing vessel.
- **Close button** Closes the Vessel setup screen and returns to the main vessel display screen.

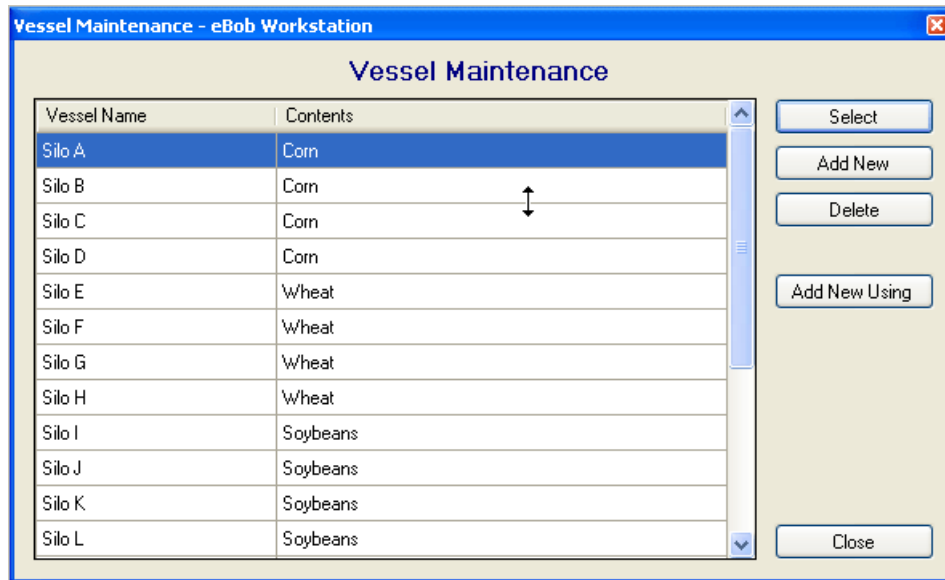

Figure 13

Tip: *The Add New Using button is a very easy way to duplicate similar vessels in the system. The Add New Using will copy the selected vessel and create a new vessel identical to the selected vessel. You must change the SmartBob Device Address before saving the vessel setup as each vessel must have a unique SmartBob hardware device address associated with it. See the SmartBob2 Remote manual for hardware address settings.*

Vessel Setup The Vessel Setup screen (Figure 14) is the most important interface in the eBob V5 Workstation software. This interface configures and defines all of the parameters about the individual vessels in the SmartBob system and is critical for volume and weight calculation accuracy.

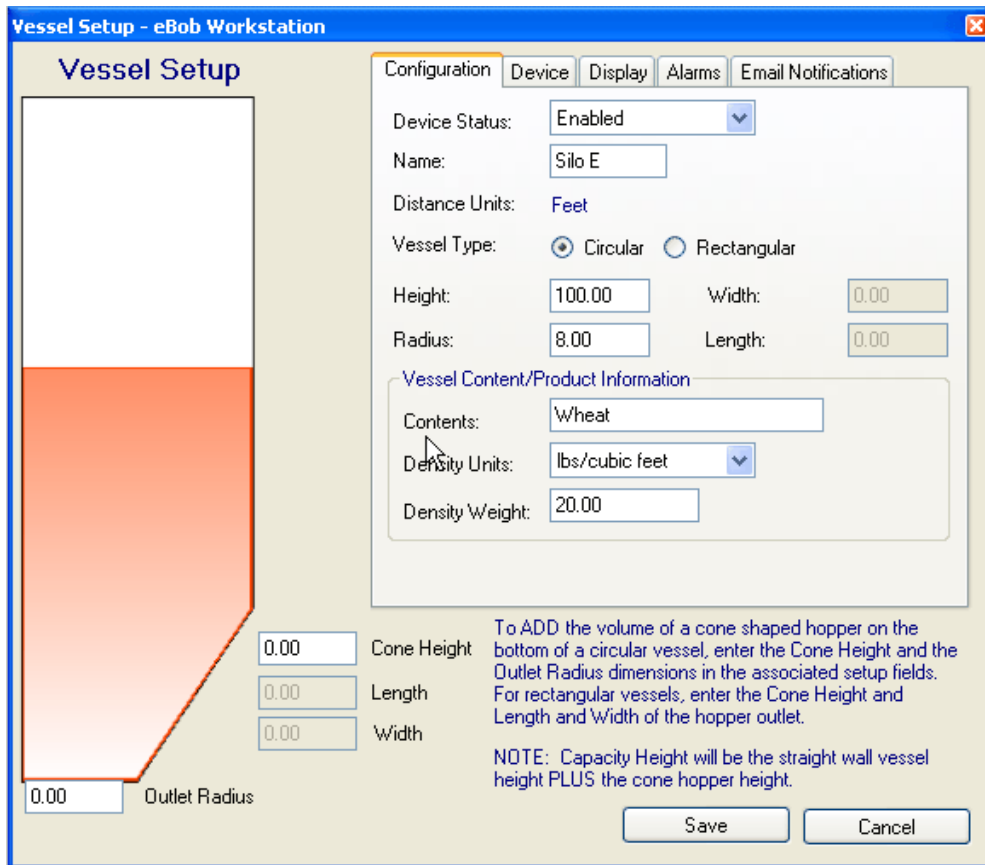

Figure 14

Configuration Tab

Device Status Enables or disables the vessel. A disabled vessel will be grayed out on the main vessel display and will not be active to measure manually or in any scheduled group measurement functions.

Vessel Name The name field describes the vessel in the system.

Tip: The main vessel display order is based on the ALPHABETICAL order of the vessel name field. Tank A, Tank B, or Silo 01, Silo 02 etc are useful naming conventions to show a particular order of vessel in the main screen.

Distance Units Defines the distance units, feet or meters of how the vessel’s size shape and measurement values are displayed in the system.

Note: This parameter is selected in the Workstation Site Setup screen and must be either feet or meters for all vessels. Default is Feet and can be changed to Meters in the Specifications | Workstation Site setup menu item.

Vessel Type Selects the shape of the vessel, either circular or rectangular, and enables the appropriate entry boxes, [height x radius] or [height x length x width] for the vessel type.

Vessel Size Defines the actual vessel dimensions for all volume calculation associated with measurements.

Note: Accurate vessel dimensions are critical for accurate volume calculations and weight calculations. Remember, the SmartBob cable based sensor measures the physical distance to the product from the top (mounting location) of the sensor. All other measurement data is calculated from vessel setup parameters.

Vessel Content / Product Information

Contents Specifies the material in the vessel for display and reporting functions.

Density Units Defines the units associated with Product Density weight (Figure 15). Options are lbs per cubic feet or gallon or yard and kg per cubic meter or liter.

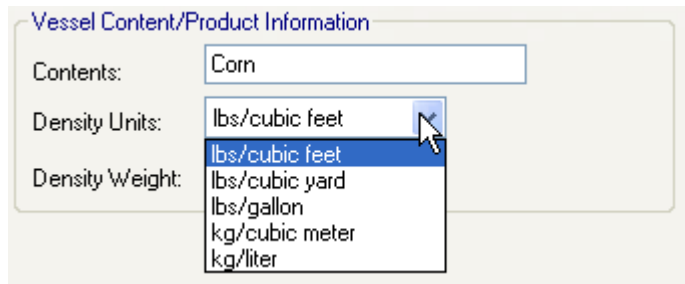

Figure 15

Density Weight Enter the Product Density value in the units defined above

Note: An accurate product density value is critical for accurate weight calculations. Remember, the SmartBob cable based sensor measures the physical distance to the product from the top (mounting location) of the sensor. All other measurement data is calculated from vessel setup parameters.

Cone or hopper bottom configuration The cone hopper configuration (Figure 16) is a convenient method to compensate for the volume or weight of a cone shaped vessel bottom.

Enter the height of the cone in the same units as the vessel dimensions, feet or meters, and the radius of the outlet opening. The software will automatically calculate the appropriate volume and apply this to the volume and weight calculations.

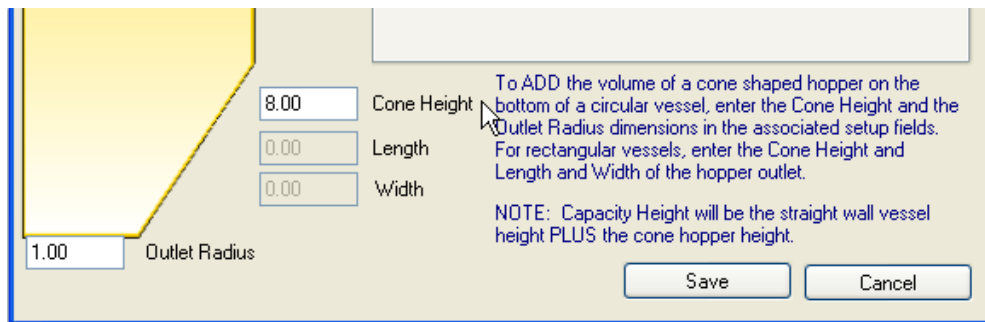

Figure 16

Device Tab (Figure 17)

Device Type Selects the type of measurement device connected to the sensor network, typically a BinMaster SmartBob sensor. Different device types may be available depending on the eBob revision.

Note: Make sure the Device Type selection (Protocol "A" or "B") agrees with the SmartBob sensor protocol jumper setting. See Figure 65 in Section 7.3.

Device Address Sets the hardware address of the sensor device connected to the RS485 network.

Note: Make sure the hardware addresses agree with the SmartBob sensor dip switch hardware address installed on the vessel. See the SmartBob2 Remote manual for hardware address settings.

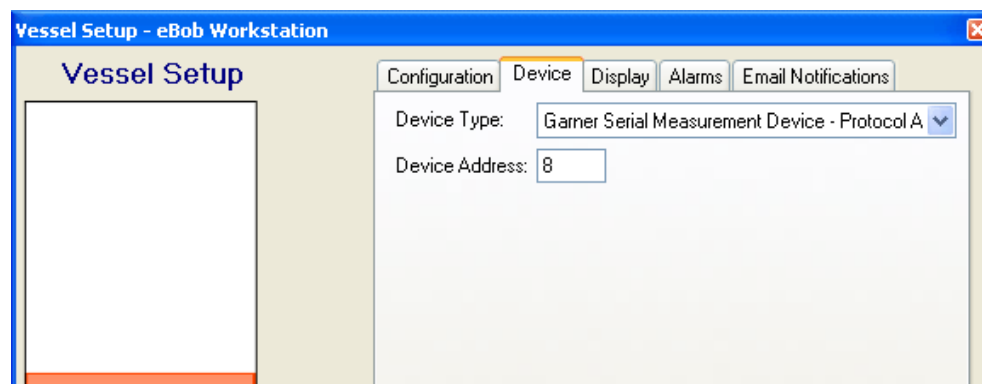

Figure 17

Display Tab

Fill Color

Selects the fill color associated with the vessel display (Figure 18). Click on the drop down box, select a color and the vessel graphic to the left will preview display the selected color

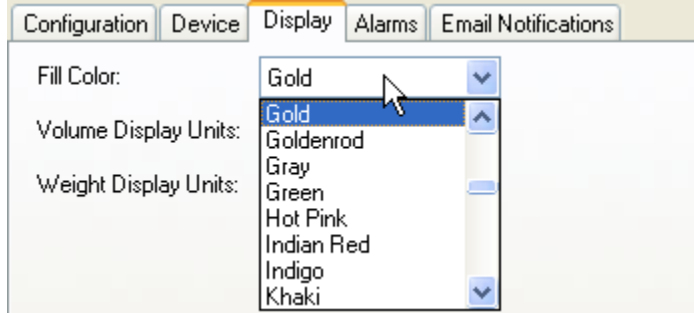

Figure 18

Volume Display Units

Selects the volume unit which will be displayed in the main screen vessel graphic and detail screen (Figure 19).

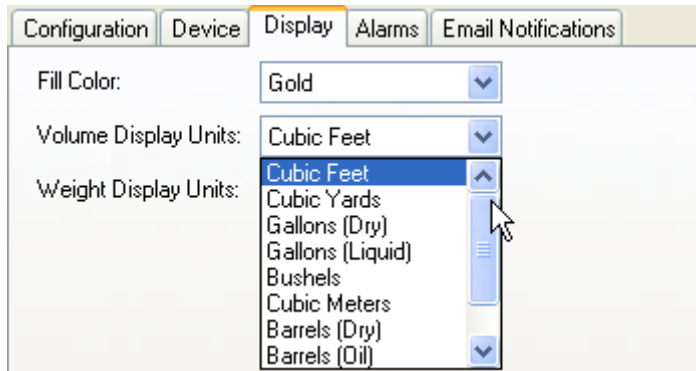

Figure 19

Weight Display Units

Selects the weight unit which will be displayed in the main screen vessel graphic and detail screen (Figure 20).

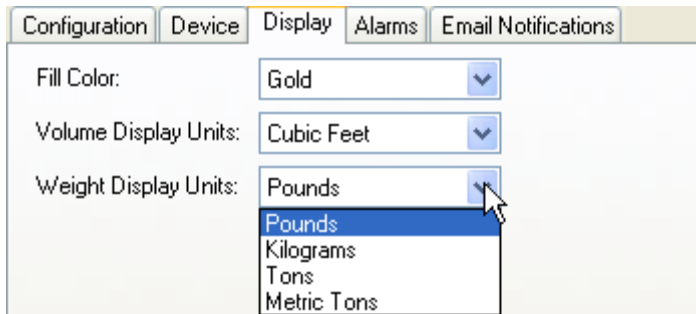

Figure 20

Alarms Tab

The Alarms tab creates up to four alarms set points associated with vessel level. The points are set as a percentage of full i.e., a 90% high alarm will trigger when a measurement is above the 90% level (Figure 21). The alarm is indicated on the main vessel display as a bold red text box indicating the alarm condition. Each alarm is enabled by checking the enabled checkbox and defining a % of full set point.

The four alarm set points are:

- High Alarm
- Pre-High Alarm
- Pre-Low Alarm
- Low Alarm

Configuration	Device	Display	Alarms	Email Notifications
<input checked="" type="checkbox"/>	High Alarm Enabled	90.00	% Full	
<input type="checkbox"/>	Pre-High Alarm Enabled	0.00	% Full	
<input type="checkbox"/>	Pre-Low Alarm Enabled	0.00	% Full	
<input checked="" type="checkbox"/>	Low Alarm Enabled	10.00	% Full	

Figure 21

Email Notifications Tab

Email notifications allow the system operator or administrator to setup and send an email message based on an alarm or error condition associated with the SmartBob2 level sensor (Figure 22). Measurement emails (Vessel Status) are also available which will send the latest measurement results to the selected contact whenever that vessel is measured.

The Email Notification controls are;

- **Enable checkbox** Enables email notifications for that vessel.
- **Select contacts** Selects the contact to email to.
- **Contact list** List of assigned contacts for email notification
- **Email Notification** Email Notification type selects the specific condition that will generate and send an email notification to the selected contacts.
 - **High Alarm** Sends email to selected contact if High alarm occurs.
 - **Pre-High Alarm** Sends email to selected contacts if Pre High alarm occurs.
 - **Pre-Low Alarm** Sends email to selected contacts if Pre Low alarm occurs.
 - **Low Alarm** Sends email to selected contacts if Low alarm occurs.
 - **Vessel Status** Sends measurement email to selected contacts each time the vessel is measured.
 - **Error Alarm** Sends email to selected contacts if an error condition occurs

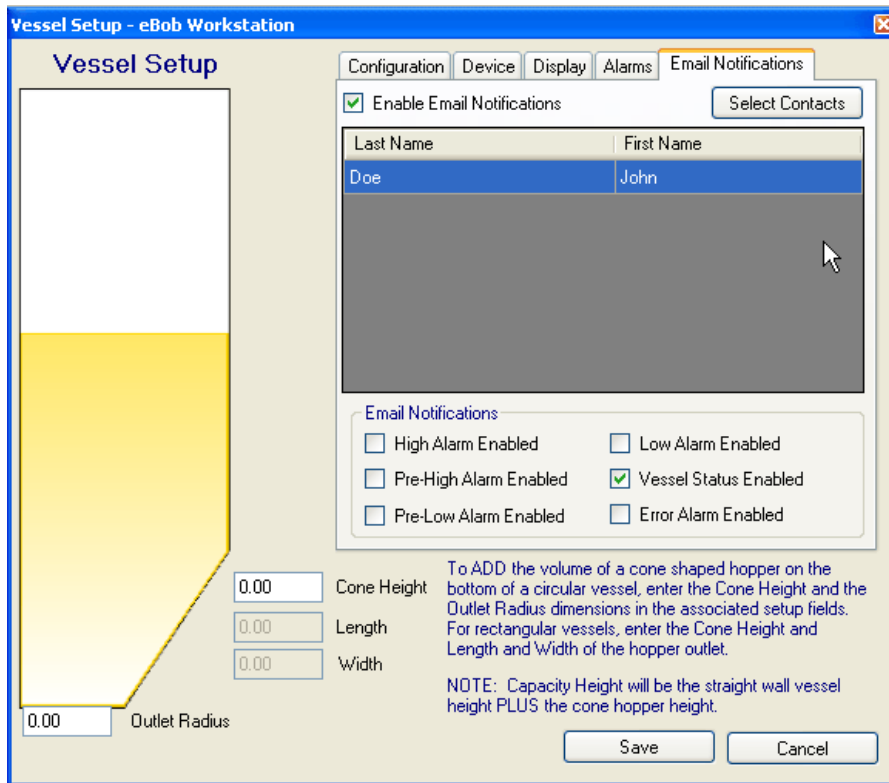

Figure 22

Note: Contacts are created in the Contact Maintenance screens in the Specifications menu.

Vessel Group Maintenance

The Vessel Group Maintenance menu allows for the creation of similar content or operational “groups” of vessels within the overall vessel system (Figure 23). Grouping vessels allows you to create measurement schedules based on the unique requirements of a particular group of vessels.

Note: A Vessel Group may have any number of vessels, from one, to all the vessels in the system.



Figure 23

- **Group list** A list of currently configured vessel groups in the system. Highlight the desired group in the list and press Select or double click the group in the list to open the setup menu.
- **Select button** Selects the highlighted group and opens the Vessel Group Setup screen.
- **Add New button** Opens the Vessel Group Setup screen.
- **Delete button** Deletes the highlighted Vessel Group from the system.

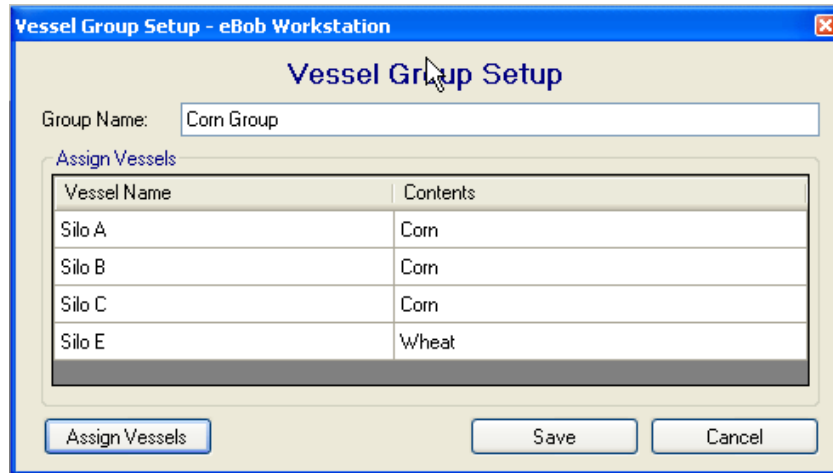

Figure 24

- **Group Name** A unique name associated with the operational “group” of vessels within the overall vessel system.
- **Assign Vessel** Opens a selection screen to assign individual vessel to the Group (Figure 25).
- **Save button** Saves any changes to the current Group.
- **Cancel button** Exits the setup screen without saving any changes.

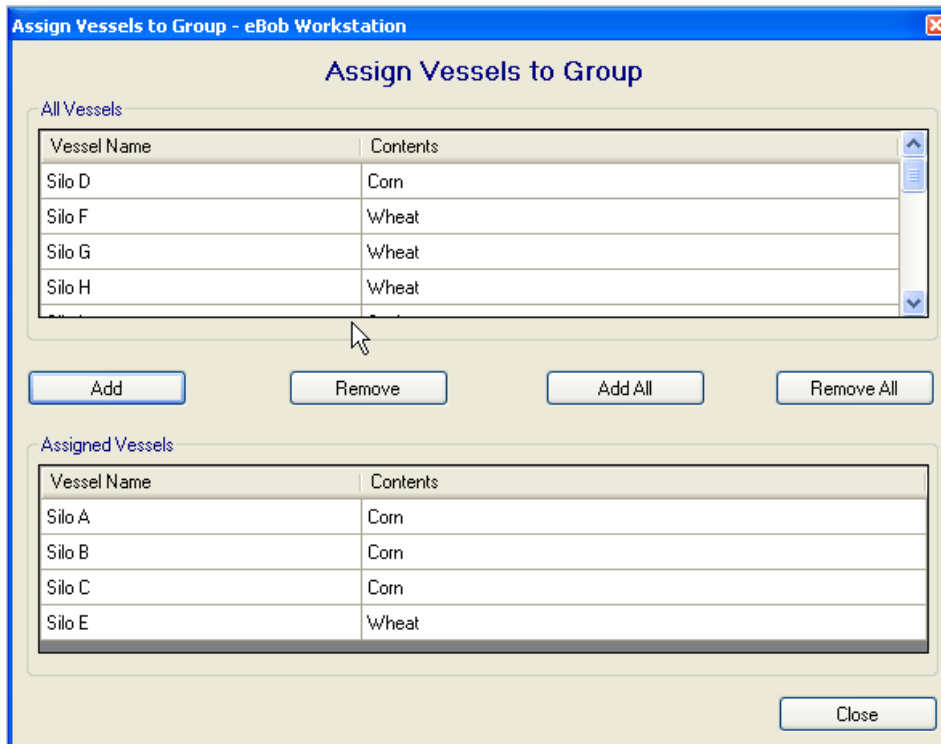

Figure 25

- **All Vessels list** A list of all the vessels in the system.
- **Assigned Vessels** A list of currently assigned vessel to the selected Group.
- **Add button** Adds the selected vessel from the All Vessel list to the Assigned Vessel list.
- **Remove button** Removes the selected vessel from the Assigned Vessel list.
- **Add All button** Adds all the vessels in the All Vessels list to the Assigned Vessel list.
- **Remove All button** Removes all the vessels in the Assigned Vessel list.
- **Close button** Closes the Assign Vessels to Group dialog box.

Schedule Maintenance

The Schedule Maintenance menu creates a unique measurement schedule for a selected Group of vessels.

Note: Automated measurements are group based and a Vessel Group must be created to assign to a specific Measurement Schedule.

A Schedule is created by clicking Schedule Maintenance | Add New. Existing Schedules may be opened and maintained by clicking on the Schedule Name in the list and clicking Select or Delete, if you wish to delete the Schedule. Once a Schedule is added or opened, the Schedule Setup dialog box appears (Figure 26).

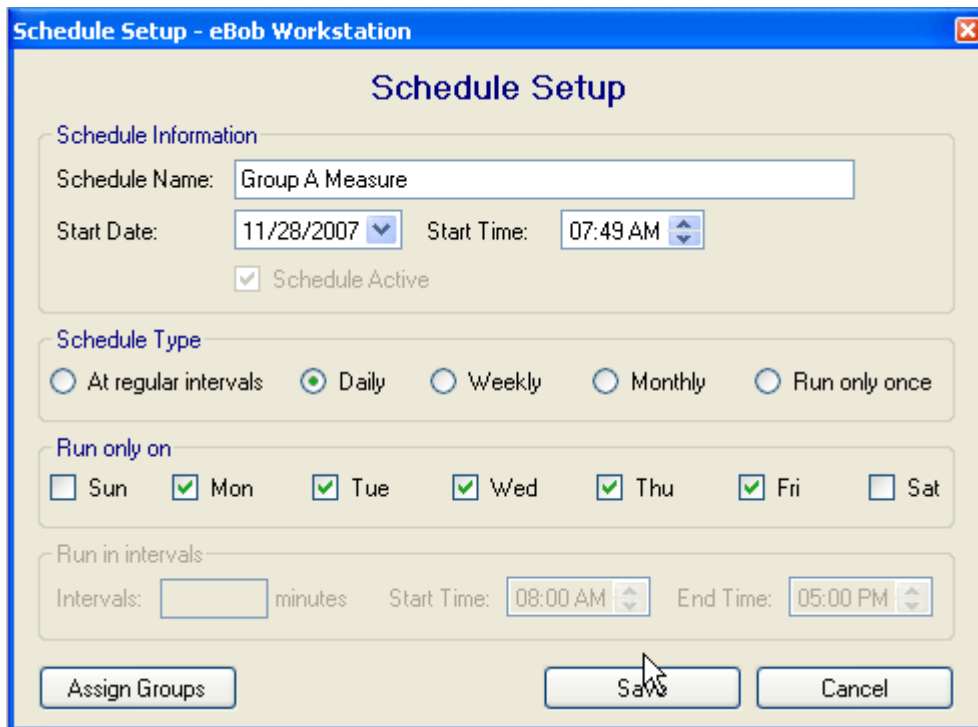

Figure 26

- **Schedule Name** Enters a unique name for the automated measurement schedule.
- **Start Date** Defines a start date for the schedule.
- **Start Time** Defines a start time for the schedule.
- **Schedule Type** Selects what type of schedule to run.
 - At regular intervals Run at intervals defined in the Run in intervals section.
 - Daily, Weekly, Monthly Run Daily, Weekly or Monthly at a specific time of day defined by Start Time.
 - Run only once Run only once at the Start Time.
- **Run only on** Selects the days of the week to run the automated schedule.
- **Run in intervals**
 - Interval Sets a repetitive interval to run the schedule in minutes
 - Start Time Sets run interval start time
 - End Time Sets run interval end time
- **Assign Groups** Assigns the particular Vessel Groups (Figure 27) to run this schedule.
- **Save** Saves changes
- **Cancel** Cancels changes in an existing dialog box

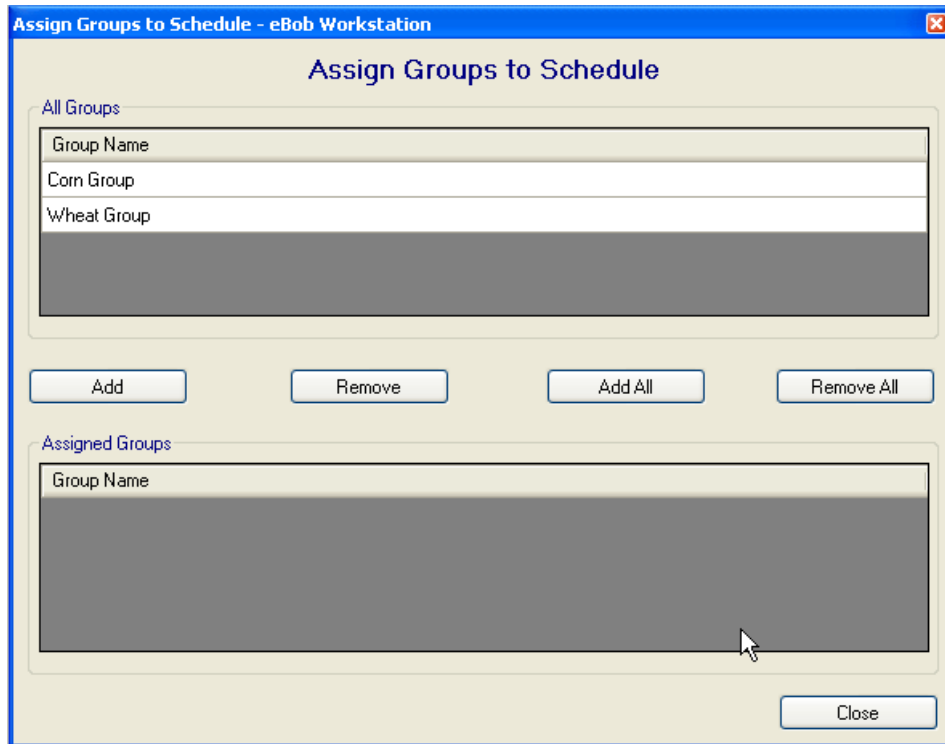

Figure 27

Temporary Group Setup

The Temporary Group function is similar to the Vessel Group but is used to define and work with a small group of vessels on a temporary basis, rather than creating a static vessel group and running a schedule (Figure 28).

Tip: A Temporary Group is useful if daily operations require a certain set of vessels that need to be measured and monitored.

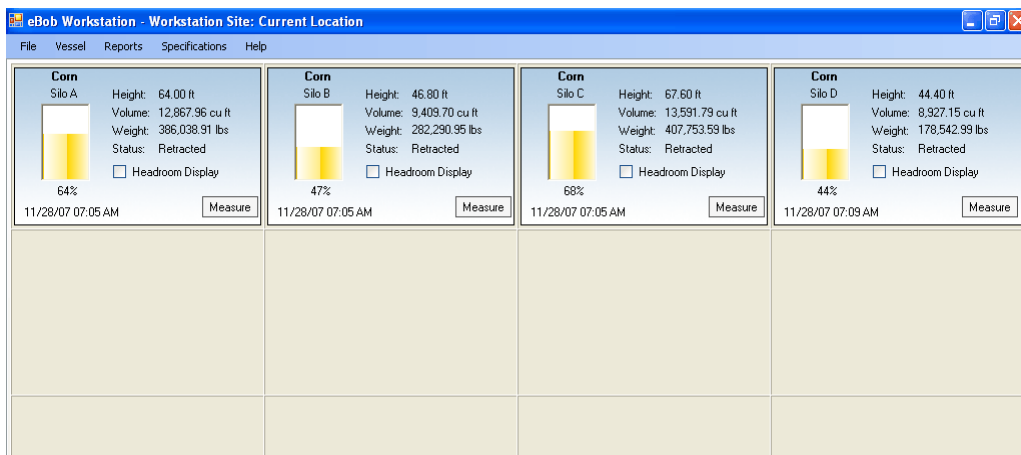

Figure 28

In the example in Figure 28, a Temporary Group of four vessels has been created. This group will then be the default vessels displayed on the main vessel screen. Each vessel may be measured individually or using the Vessel | Measure All Vessel command.

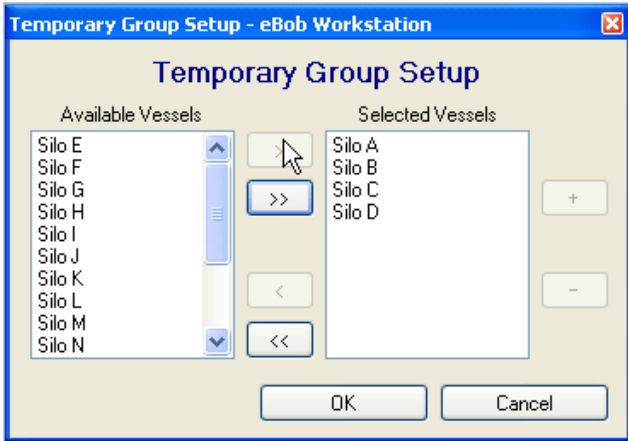

Figure 29

- **Available Vessel list** A list of all the vessel in the system that may be added to the Temporary Group (Figure 29).
- **Selected Vessels list** A list of the vessel currently in the Temporary Group.
- **Add / Remove arrows** Right arrows add the selected available vessel to the Selected vessel list, left arrows remove the selected vessel.
- **Move Up / Down** Changes the order of the how the vessel are display on the Main Vessel display.

Measure All Vessels

The Measure All menu item is a handy way to measure all of the vessels in the system (Figure 30).

Note: For a large system, it may take several minutes for each of the SmartBob sensors to complete a measurement cycle. The Status line on the vessel icon will update as the measurement progresses and the time / date stamp below the vessel graphic will update when the measurement is complete.

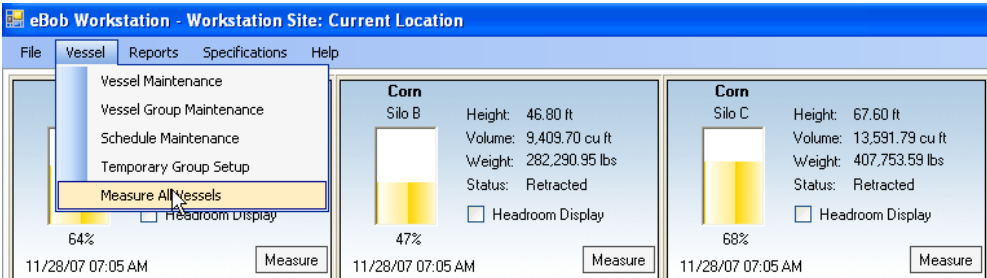

Figure 30

3.2.3 Reporting

A key functionality of the eBob Version 5 software is flexible reporting of current and historical vessel measurements. The Reporting module in eBob V5 uses Crystal Report redistributable to query the eBob SQL database and generate standard and custom reporting options (Figure 31).

Most reports may also be exported to different file formats supported by Crystal or can be exported as a raw data file (.csv) for import into other applications.

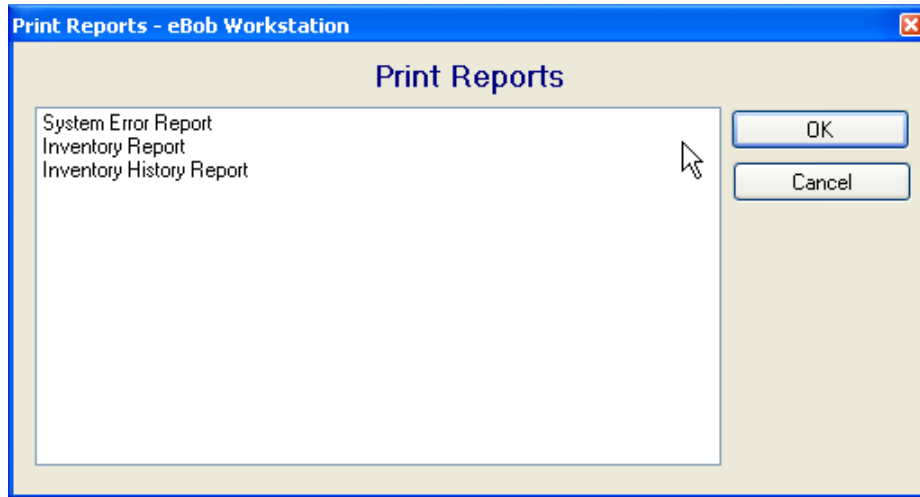

Figure 31

Three basic reporting options exist:

- **System Error** Prints or exports a report of any system errors that eBob has logged.
- **Inventory Report** Prints or exports a report of the *current* inventory in selected vessels.
- **Inventory History Report** Prints or exports *historical* inventory data associated with a particular vessel.

Inventory Reporting (Figure 32)

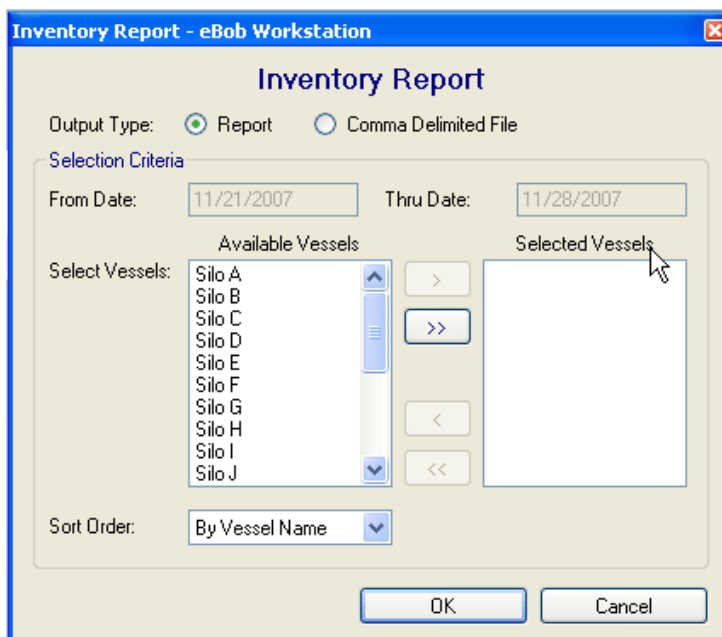

Figure 32

- **Output Type** Selects Print report or Export report output.
- **Selection Criteria** Defines what vessels and how to sort the output data.

Note: Since the inventory report is the current inventory of the vessel, the From and Thru Date entry fields are not active.

- **Available Vessels** A list of all the vessels in the system that may be added to the Report or Export.
- **Selected Vessels** A list of the vessel currently selected to Report or Export against.
- **Add / Rem arrows** Right arrows add the selected available vessel to the Selected Vessel list, left arrows remove the selected vessel.
- **Sort Order** Selects to sort the output by Vessel Name or Vessel Contents alphabetically.

Report Examples

Inventory Report

Main Report

From Date: 11/21/2007
Thru Date: 11/28/2007

eBob Workstation
Inventory Report (Current Location)

11/28/2007
8:05:41AM

Vessel Name	Vessel Contents	Measurement Date	Product Volume	Product Weight	Product Height	Head room Volume	Head room Weight	Head room Height	% Full
Silo A	Corn	11/28/07 07:01 AM	12,848.88cuft	384,039.00lbs	44.00#	7,238.23cuft	217,147.00lbs	34.00#	44%
Silo B	Corn	11/28/07 07:01 AM	9,469.78cuft	282,291.00lbs	44.00#	10,494.50cuft	326,895.00lbs	33.00#	47%
Silo C	Corn	11/28/07 07:01 AM	13,591.80cuft	407,754.00lbs	47.40#	4,514.41cuft	195,433.00lbs	32.40#	68%
Silo D	Corn	11/28/07 07:09 AM	8,927.15cuft	178,543.00lbs	44.40#	11,179.00cuft	223,381.00lbs	55.40#	44%
Silo E	Wheat	11/28/07 07:09 AM	13,370.18cuft	245,403.00lbs	44.00#	4,834.11cuft	134,722.00lbs	34.00#	44%
Silo F	Wheat	11/28/07 07:01 AM	4,475.24cuft	133,505.00lbs	33.20#	13,430.90cuft	248,419.00lbs	64.80#	33%
Silo G	Wheat	11/28/07 07:01 AM	10,053.10cuft	201,042.00lbs	50.00#	10,053.10cuft	201,042.00lbs	50.00#	50%
Silo H	Wheat	11/28/07 07:01 AM	18,095.40cuft	341,911.00lbs	90.00#	2,010.42cuft	40,212.40lbs	10.00#	90%
Silo I	Soybeans	11/28/07 07:01 AM	3,214.90cuft	44,339.80lbs	14.00#	14,889.20cuft	337,784.00lbs	86.00#	14%
Silo J	Soybeans	11/28/07 07:01 AM	10,053.10cuft	201,042.00lbs	50.00#	10,053.10cuft	201,042.00lbs	50.00#	50%
Silo K	Soybeans	11/28/07 07:01 AM	10,214.00cuft	204,279.00lbs	50.00#	9,892.25cuft	197,845.00lbs	49.20#	51%
Silo L	Soybeans	11/28/07 07:09 AM	4,745.84cuft	94,901.20lbs	23.40#	11,341.18cuft	307,223.00lbs	74.40#	24%
Silo M	Milo	11/28/07 07:01 AM	3,134.57cuft	42,731.30lbs	15.40#	14,949.40cuft	14,803.00lbs	86.40#	14%
Silo N	Milo	11/28/07 07:01 AM	17,413.00cuft	372,241.00lbs	87.40#	2,499.17cuft	49,843.40lbs	12.40#	88%
Silo O	Milo	11/28/07 07:08 AM	18,988.30cuft	379,405.00lbs	94.40#	1,125.95cuft	22,518.90lbs	5.40#	94%
Silo P	Milo	11/28/07 07:01 AM	4,755.48cuft	135,114.00lbs	33.40#	13,330.50cuft	247,010.00lbs	64.40#	34%
Silo Q	Feed	11/28/07 07:01 AM	10,133.50cuft	202,470.00lbs	50.40#	9,972.47cuft	199,453.00lbs	49.40#	50%
Silo R	Feed	11/28/07 07:01 AM	1,849.77cuft	34,995.40lbs	9.20#	18,254.40cuft	345,128.00lbs	90.80#	9%
Silo S	Feed	11/28/07 07:01 AM	12,544.30cuft	250,925.00lbs	42.40#	7,559.99cuft	151,199.00lbs	37.40#	42%
Silo T	Feed	11/28/07 07:01 AM	15,482.88cuft	313,457.00lbs	78.00#	4,423.34cuft	88,473.80lbs	22.00#	78%

Figure 33

Tip: Crystal Reports offers advanced features for printing and saving reports in various formats, such as Acrobat, Word and Excel formats. See the Export and Print toolbar items in the Crystal Reports viewer.

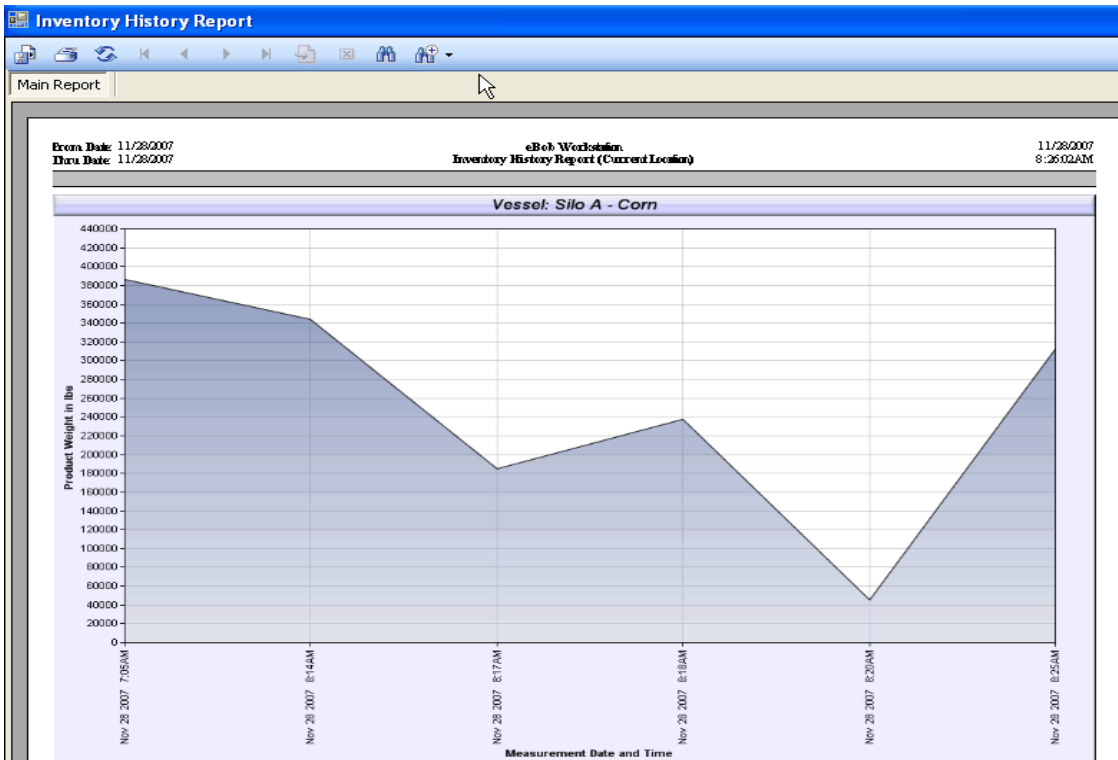

Figure 34

Example of an Export Report

(Figure 35)

	A	B	C	D	E	U	V	W
1	Measure Date	Measure Time	Workstation Site	Product Name	Vessel Name	Measurement In Feet	Measurement In Meters	Product Density Weight
2	11/28/2007	7:05:00 AM	Current Location	Corn	Silo A	36	10.97	386039
3	11/28/2007	7:05:00 AM	Current Location	Corn	Silo B	53.2	16.22	282291
4	11/28/2007	7:05:00 AM	Current Location	Corn	Silo C	32.4	9.88	407754
5								
6								
7								
8								
9								
10								
11								
12								
13								
14								
15								
16								
17								
18								
19								
20								
21								
22								
23								
24								
25								
26								
27								

Figure 35

Exporting a report creates a comma separated values data file of all data associated with a measurement record. The “CSV” file not only contains the last measurement data, but all the dimensional, units, content, and timestamp information associated with a particular measurement.

Email Reports

An additional reporting option eBob V5 features is the ability to email the last measurement, a “Site Status” email, to selected contacts.

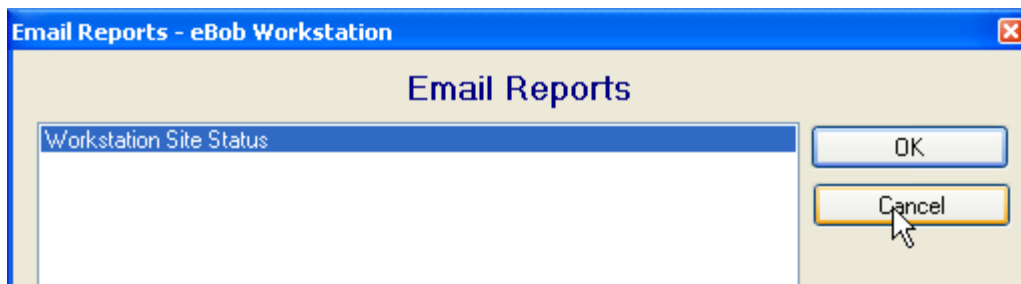

Figure 36

The Workstation Site Status email (Figure 37) works very much like the Scheduler function for automated group measurements. An “email schedule” is created to allow the system to send current measurement data on a predefined schedule and contact list.



Figure 37

- **Schedule Name** Default name is “Workstation Site Status” and is not changeable.
- **Start Date** Defines a start date for the email schedule.
- **Start Time** Defines a start time for the email schedule.
- **Schedule Type** Selects what type of schedule to run.
 - At regular intervals Run at intervals defined in the Run in intervals section.
 - Daily, Weekly, Monthly Run Daily, Weekly or Monthly at a specific time of day defined by Start Time.
 - Run only once Run only once at the Start Time.
- **Run only on** Selects the days of the week to on which to send automated emails.
- **Run in intervals**
 - Interval Sets a repetitive interval to run the schedule in minutes.
 - Start Time Sets run interval start time.
 - End Time Sets run interval end time.
- **Assign Contacts** Assigns the particular contacts to send the emails to.
- **Save** Saves changes.
- **Cancel** Cancels changes and exits the dialog box.

Tip: A Site Status email schedule does not take a vessel measurement before collecting and emailing the data. A common implementation is to schedule an automated Group Measurement shortly before a Site Status email so the data report is kept current.

3.2.4 Specifications Menu

Contact Maintenance

The Contact Maintenance menu (Figure 38) is used to create and manage a contact list for the various emails functions of eBob V5 software.

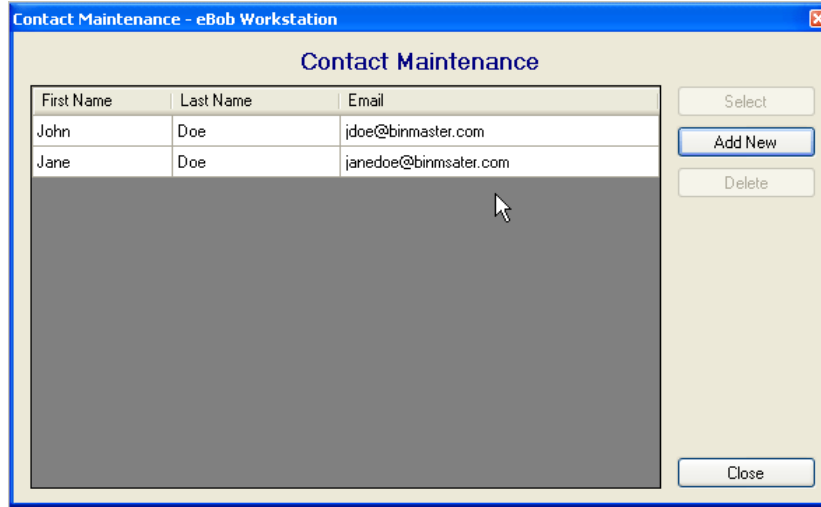

Figure 38

- **Contact list** A list of currently defined contacts in the system. Highlight the desired contact in the list and press Select or double click the contact in the list to open the setup menu.
- **Select button** Selects the highlighted contact and opens the Contact Setup screen.
- **Add New button** Opens the Contact Setup screen with a new, blank contact entry.
- **Delete button** Deletes the highlighted contact from the list.

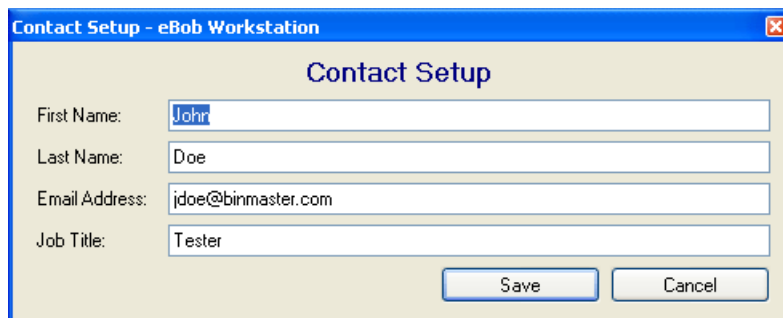

Figure 39

Information regarding the contact is entered in the Setup dialog (Figure 39), most importantly, the contact’s email address.

eBob Workstation Site Setup

An eBob Workstation Site is loosely defined as a “site or facility with a PC and an associated SmartBob sensor network”. A site ID is needed for advanced configurations of eBob software which can interface with multiple, different SmartBob sensor networks.

Workstation Site setup (Figure 40) enters basic information about the sensor site or facility.

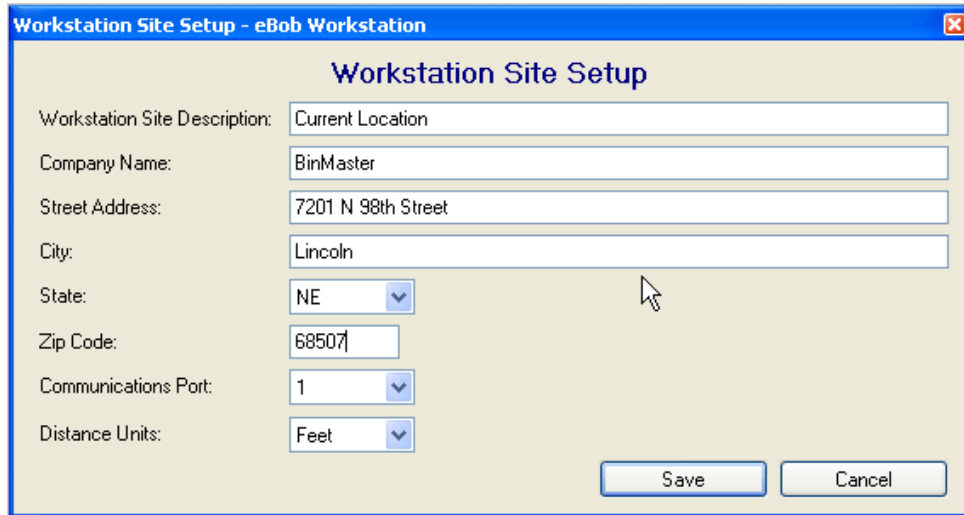

Figure 40

Enter basic facility information about the eBob Workstation Site, such as a unique Site name, company or division name, address, etc.

Communications Port Selects the serial communications port (COM) to which the SmartBob sensor network is connected to via the Serial Interface box.

Distance Units Sets what distance units are used for vessel parameters, feet or meters.

System Setup (Advanced)

An eBob “System” is loosely defined as a “the overall organization associated with MULTIPLE eBob Workstation Sites” (Figure 41). This data is mostly applies when multiple SmartBob networks exist within an organization.

Note: The System Setup dialog also has two general items for configuration.

“Measurement Retention Days”

How long data is stored in the SQL database.

Note: The default setting for data retention is 60 days. If you desire a longer retention period, adjust this setting to the desired number of days.

“Do not require users to login”

Opens eBob to admin user by default and does not require any login.

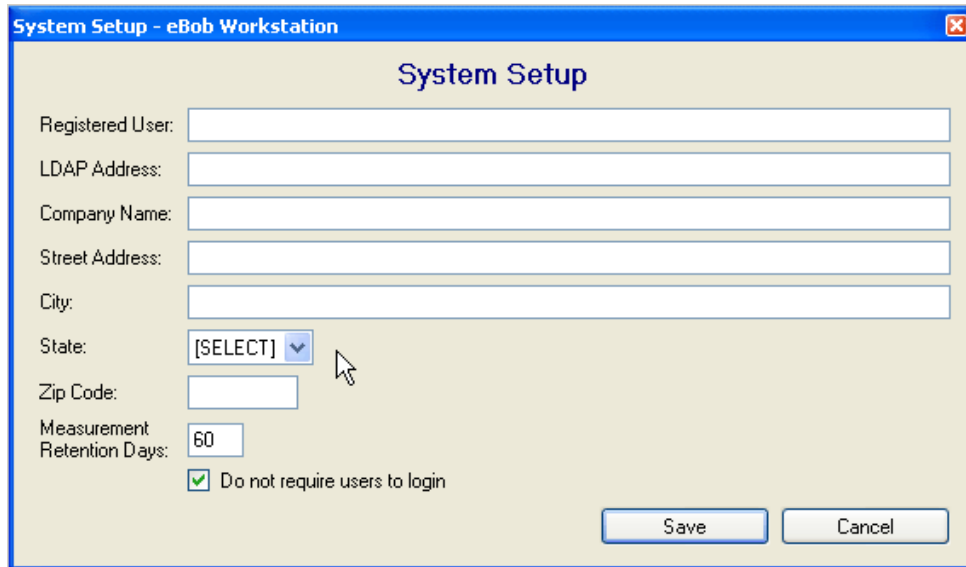

Figure 41

Email Setup

The Email Setup menu item configures the SMTP server and specific email parameter which are used for individual vessel emails for the Site Status Email report.

Note: It is critical that SMTP and authentication details are entered correctly for the email function to operate properly. Check all settings with your network IT support or Internet Service Provider.

Figure 42

- **Use SMTP Auth.** SMTP server requires authentication, so use the name and password to authenticate when connected to SMTP server.
- **SMTP Server name** SMTP server to connect to.
- **User ID** SMTP user ID (required by most ISP's)
- **Password** Password (required by most ISP's)
- **SMTP Port** Sets the SMTP port required by server. Default is 25.
- **Email addresses** Allows the user to enter default email addresses which will be used in the From subject line.
- **Message Subject** Allows the user to customize the email subject associated with admin, measurement and Alarm email types.
- **Email Append** Standard email trailer defined by the user.

4.0 Windows Services

As defined by Microsoft, a “Windows Service is a long-running executable program that performs specific functions and which is designed not to require user intervention. These services can be automatically started when the Microsoft Windows operating system boots and run in the background as long as Windows is running. These features make services ideal for use on a server or whenever you need long-running functionality that does not interfere with other users who are working on the same computer.”

The eBob V5 has two components implemented as Windows Services (Figure 43).

1. **eBob Engine Service.** The core communications, measurement and data storage processes are controlled by the eBob Engine Service. This process runs in the background and the fact that it is a windows service allows the measurement to be taken without the user interface open and can recover (restart) if a system error occurs or the PC reboots.
2. **eBob Scheduler Service.** The Scheduler service is essentially a “task manager” process also running in the background. The Scheduler manages automated tasks, such as daily measurements or email reports and also benefits being a windows service to allow recover (restart) if a system error occurs or the PC reboots.

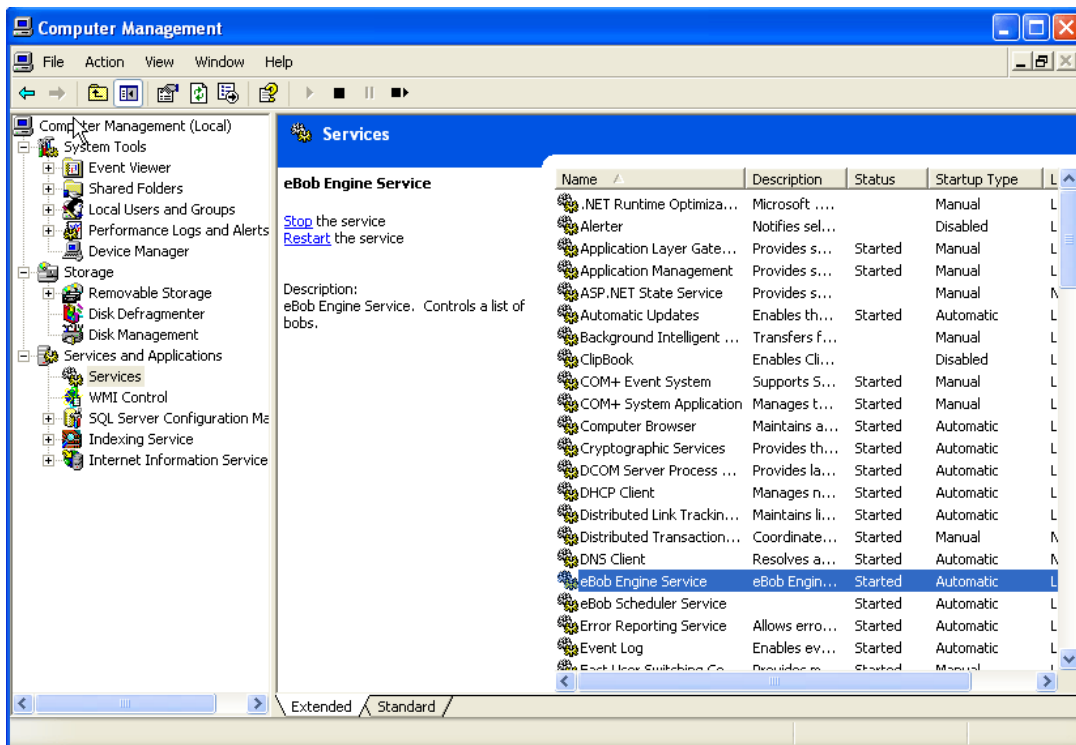

Figure 43

Managing Services

Note: Modifying windows service operation is recommended for advanced users only.

Once a service is installed, it can be managed by launching Services from the Windows Control Panel | Administrative Tools. The Services management console (Figure 44) provides a brief description of the service functions and displays the path to the service executable, its current status, startup type, dependencies and the account under which the service is running. It enables users to:

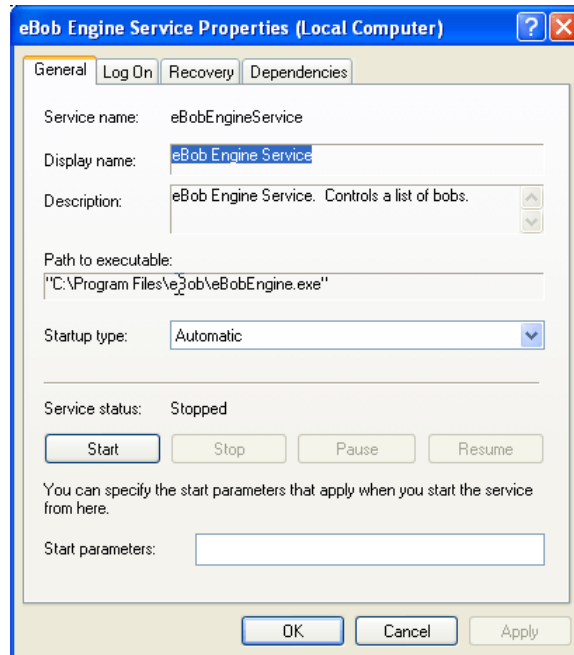

Figure 44

- Start, stop, pause or restart services.
- Specify service parameters.
- Change the startup type which includes Automatic, Manual and Disabled. Automatic starts the services at system logon, Manual starts a service as required or when called from an application, Disabled completely disables the service and prevents it and its dependencies from running. Windows Vista also introduces a new Automatic (Delayed) startup type to start the service a short while after the system has finished booting, so the system boots up faster.
- Change the account under which the service logs on.
- Configure recovery options upon service failure.

Note: The eBob Engine and Scheduler are installed as “Automatic” during installation and will reload any time Windows boots-up.

5.0 Advanced Network Configurations

eBob Version 5 supports several advanced network configurations to allow multiple users to view and report measurement data.

Note: Advanced networking configurations requires knowledge pertaining to the IT and TCP/IP structure of the LAN / WAN / VPN eBob V5 will be operating on.

Definitions:

eBob Workstation Controller	An installation of eBob V5 software that <i>is</i> connected to and controls the actual SmartBob sensors via a serial port.
eBob Workstation Viewer	An installation of eBob V5 software that <i>is not</i> connected to the sensor hardware, but is connected to the eBob SQL database via a TCP/IP connection.
LAN / WAN / VPN	TCP/IP based network which connects a group of PCs over a physical connection
Microsoft SQL Server Express	SQL Server is a free, downloadable and distributable version of Microsoft's SQL Server relational database management system.
Internet	<i>Public</i> TCP/IP based network also known as the World Wide Web. LAN remote connection are supported by eBob V5, but public Internet connections re not currently support for remote Viewer or Controller applications.

5.1 eBob “Viewer” Connections

In networking modes of operation, eBob V5 software may be installed as a data “Viewer” or client on a local area network. In viewer operation, eBob connects to the SQL database of the system that is connected to the SmartBob network (Figure 45).

In Figure 45, PC1 is installed and configured as the controller system for the SmartBob network. All setup and measurement history is contained in a SQL database. PC’s 2 and 3 then connect to the master SQL database to view and report measurement information.

Note: Live measurements cannot be started from an eBob installation configured as a Viewer.

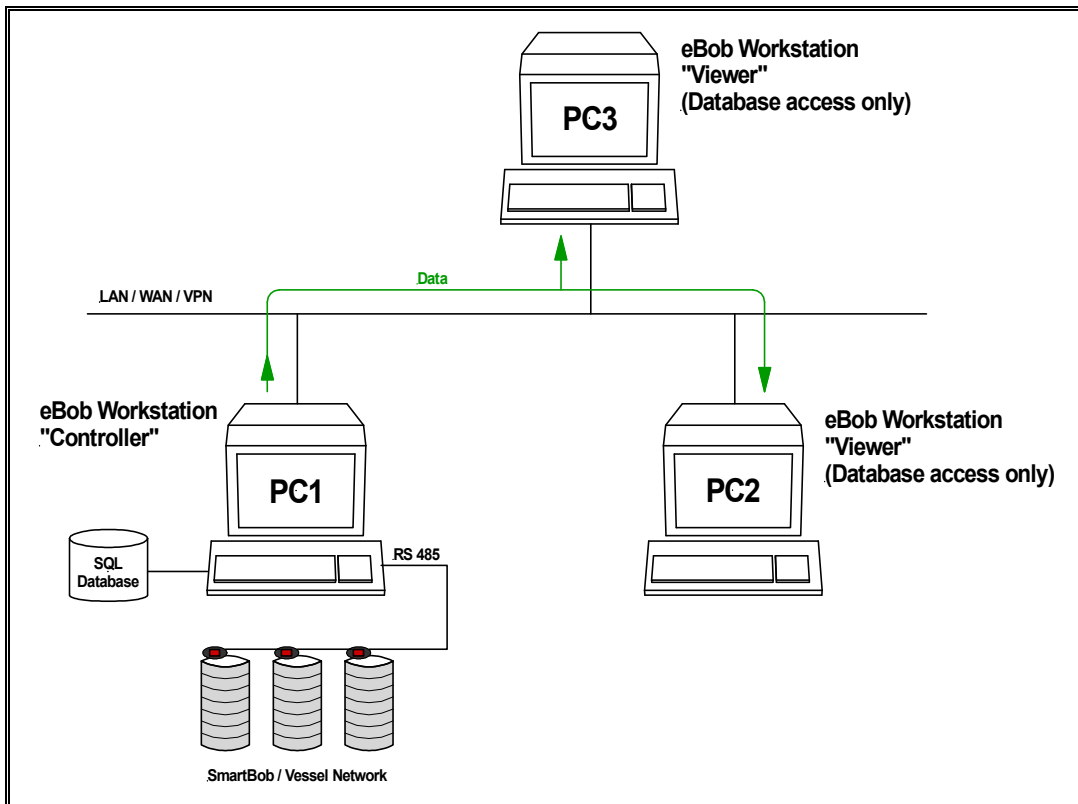

Figure 45

Note: See Section 6.1.1 for information how to install and configure eBob V5 Workstation as a database “Viewer”.

5.2 eBob “Viewer” and Multiple SmartBob Networks

Figure 46 shows an installation with multiple SmartBob sensor networks running eBob V5 software, PC1 and PC2 in the diagram. In this mode of operation, an eBob Viewer may be installed on another PC on the network, PC3, and connect to the common SQL database both SmartBob Controllers are connected to.

In this configuration, PC3 can switch between reporting PC1’s or PC2’s data by selecting the Workstation Site ID for the two sites. See Section 3.2.4, Specifications Menu | Workstation Site Setup for Site ID configuration.

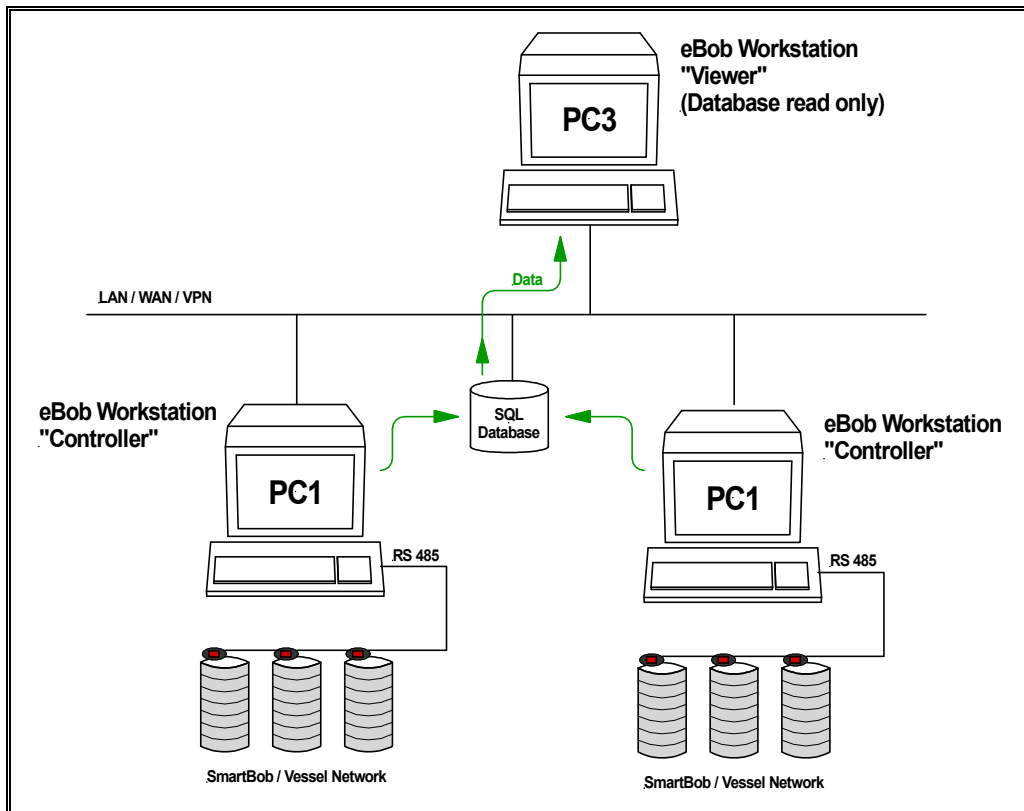

Figure 46

5.3 Multiple eBob Controllers

An additional option is to create multiple eBob Workstation “Controllers” that connect to a single PC running eBob Workstation. Reference Figure 47.

In this example PC2 and PC3 are configured as true “Controllers” of the SmartBob network connected to PC1. In addition to connecting to a common SQL database, a true controller configuration also connects remotely to the Measurement and Scheduler engine services running on PC1. This connection allows PC2 and PC3 to control SmartBob measurements.

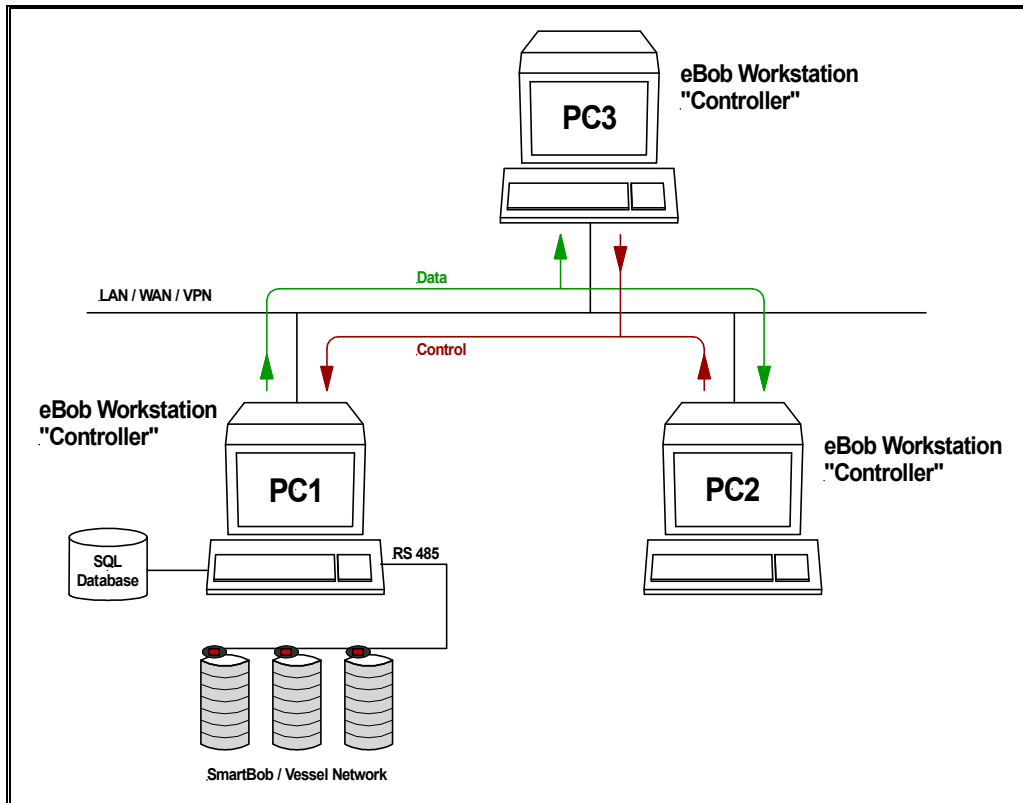

Figure 47

5.4 Non-supported network configurations

Figure 48 shows a non-supported network configuration. eBob Workstation cannot be configured to connect to multiple SmartBob networks for remote control.

PC1 and PC2 are two different SmartBob networks connected via a LAN or WAN. PC3, also connected to the LAN, is being considered for control of both SmartBob site.

Note: Because of the requirement of a TCP/IP connection to the host PC Measurement and Scheduler Services controlling the SmartBob sensor, PC3 cannot switch between controlling two SmartBob networks.

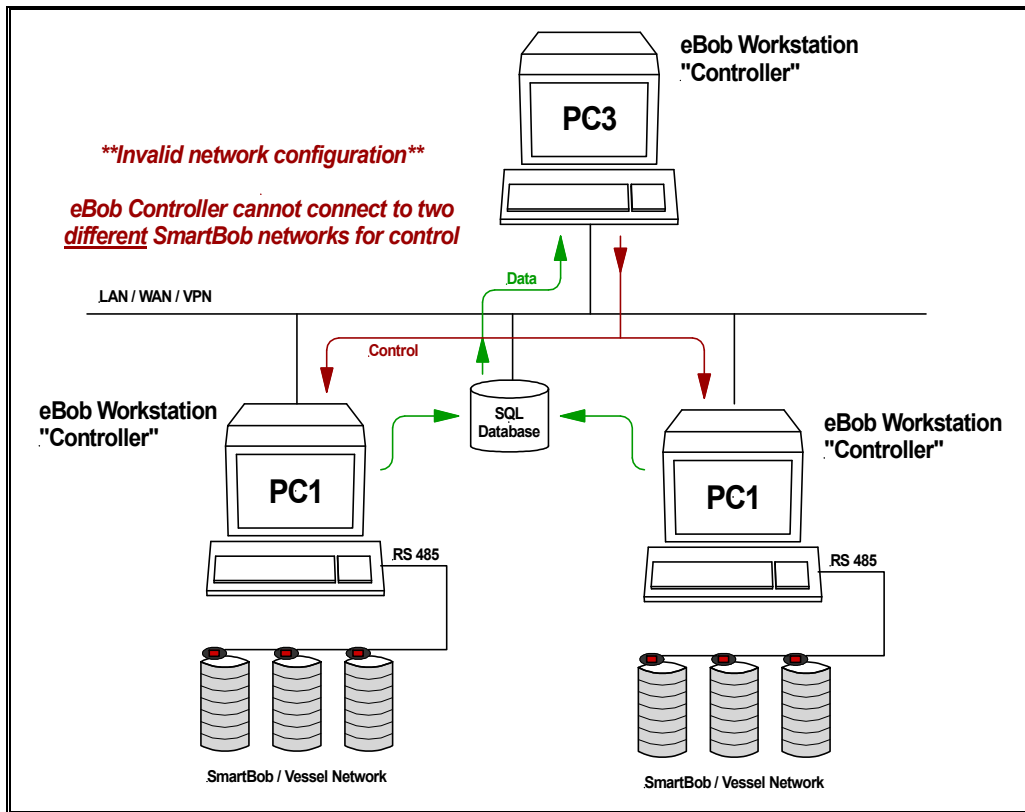

Figure 48

6.0 Advanced Installations

Note: Advanced networking configurations requires knowledge pertaining to the IT and TCP/IP structure of the LAN / WAN / VPN eBob V5 will be operating on.

6.1.0 Installing eBob V5 as a Single Controller

See Section 1.1 Quick Setup Guide for eBob V5 installation on a PC.

6.1.1 Creating an eBob Viewer Connection

Note: An eBob Viewer installation requires that an eBob Controller PC has been setup and is available on the LAN or WAN. Reference Figure 45.

For an eBob Viewer connection, SQL Express must be configured on the host or controller PC to allow remote connections via the TCP/IP network so the Viewer or “client” installation can connect to the controller eBob SQL database. To allow remote connections to a SQL database on the controller PC:

Go to Start | Program | Microsoft SQL Server 2005 | Configuration Tools | SQL Server Surface Area Configuration.

On the next screen, select “Surface Area Configuration for Services and Connections” and then select “Remote Connections”, shown in the navigation panel (Figure 49). Check “Local and remote connections” and select TCP/IP or Named connection depending on your network configuration.

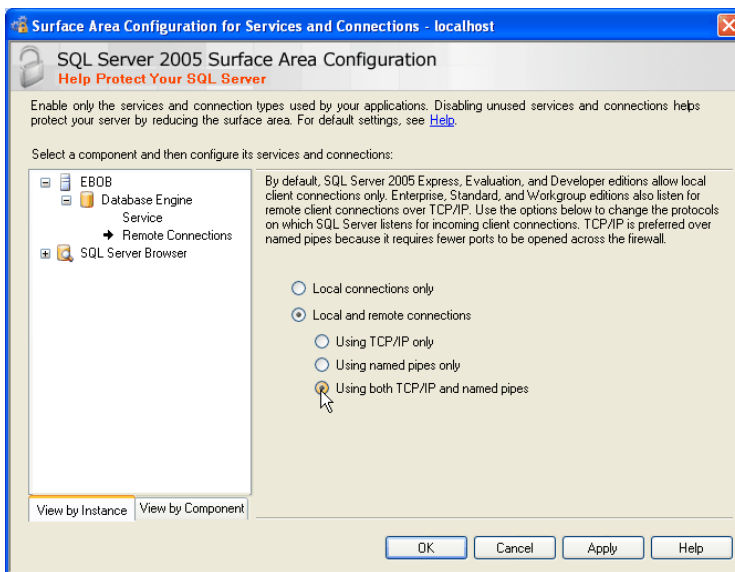

Figure 49

6.1.2 Installing eBob V5 as a Viewer

Start the install process on the remote PC by navigating to the root of the eBob V5 Distribution CD and clicking “setup.exe” or open Control Panel | Add or Remove Programs | Add New Program, then choose CD or Floppy. Browse to the root of the distribution CD and select “setup.exe”.

After agreeing to the EULA, the installation package will display a selection box with Easy or Advanced installations. Select Advanced Installation (Figure 50).

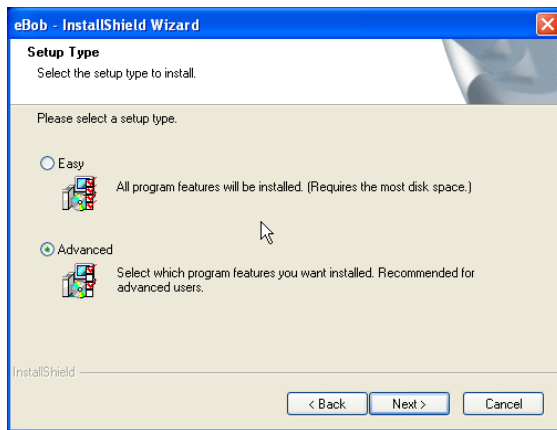

Figure 50

The next screen (Figure 51) will ask you to select which eBob component to install: the eBob Workstation application (User Interface), SQL Express and the eBob SQL database, or the Measurement Engine and Scheduler services. Select “Application” as shown in Figure 51

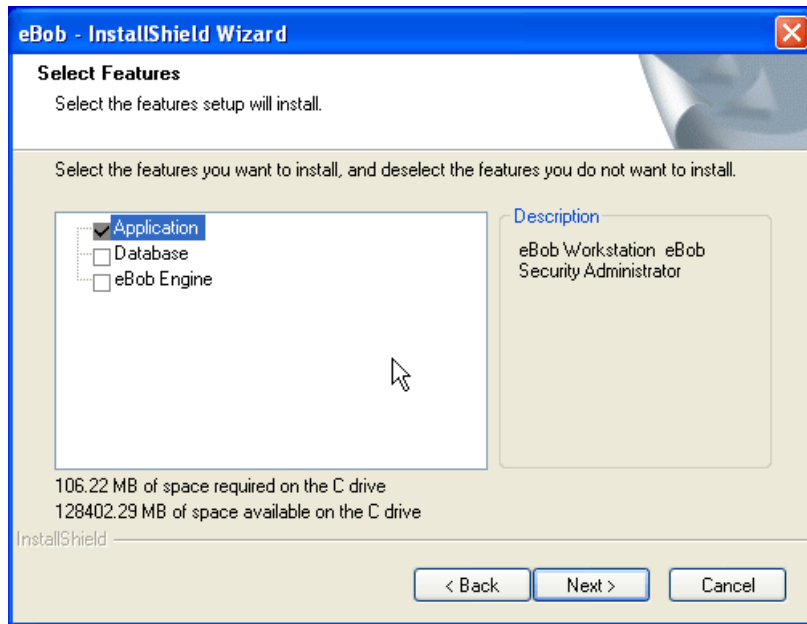

Figure 51

The next screen will ask you where to install the eBob Application. The default path is C:\Program Files\ eBob and is the recommended installation path.

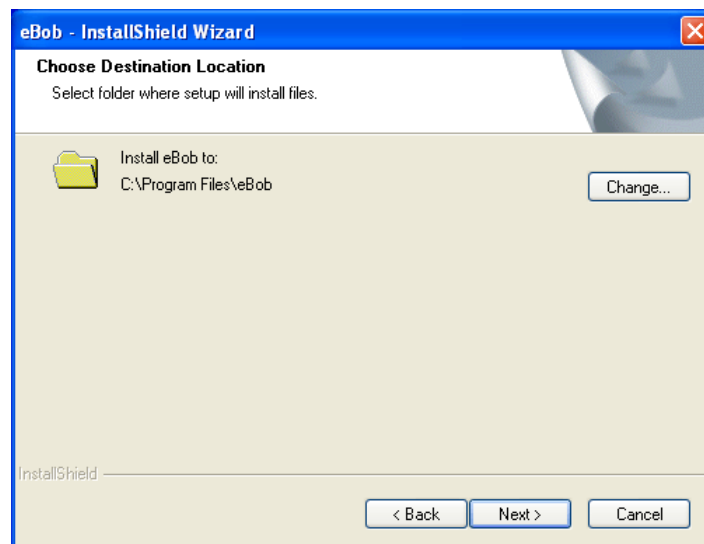

Figure 52

The installer will then complete the installation of the eBob Workstation application. The final step is to connect the eBob user interface to the database using the eBob Security Administrator.

6.1.3 Connecting eBob Viewer to a remote SQL database

Go to Start | Program | eBob | eBob Security Administrator. Highlight “eBob Workstation” in the selection list and then Select.

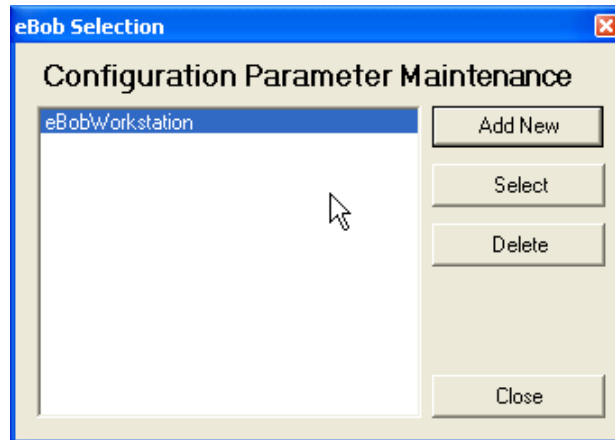

Figure 53

On the parameters configuration screen Data Source field, enter the [machine name or IP address] \ eBob of the connection to the remote database. In most cases, no other changes are necessary for a remote viewer connection.

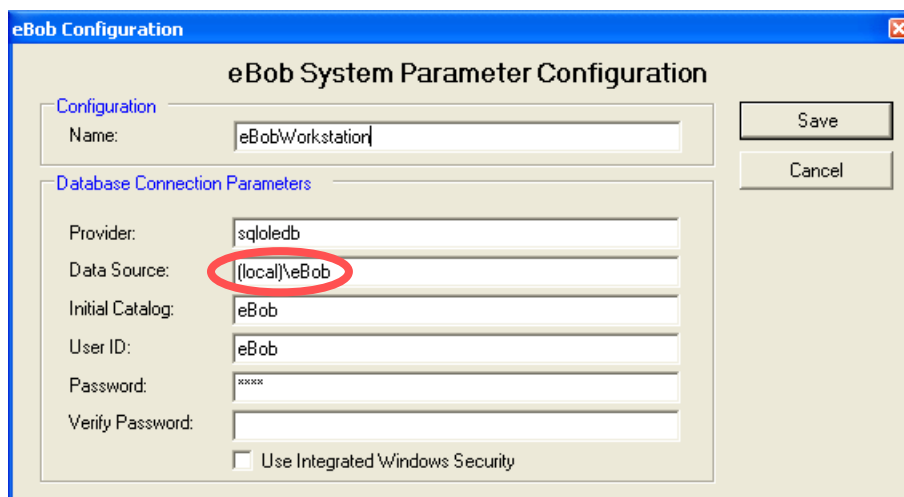

Figure 54

Note: The default SQL User ID and password are “eBob” and “eBob” (case sensitive) respectively and the correct password will need to be entered in the Verify Password entry box to Save any changes.

When eBob Workstation is started on the remote PC, the main screen vessel icons will report a “Database read only” (Figure 55) in the status area of the vessel display. This indicates that the software is connected to the database reading data rather than being directly connected to the SmartBob network.

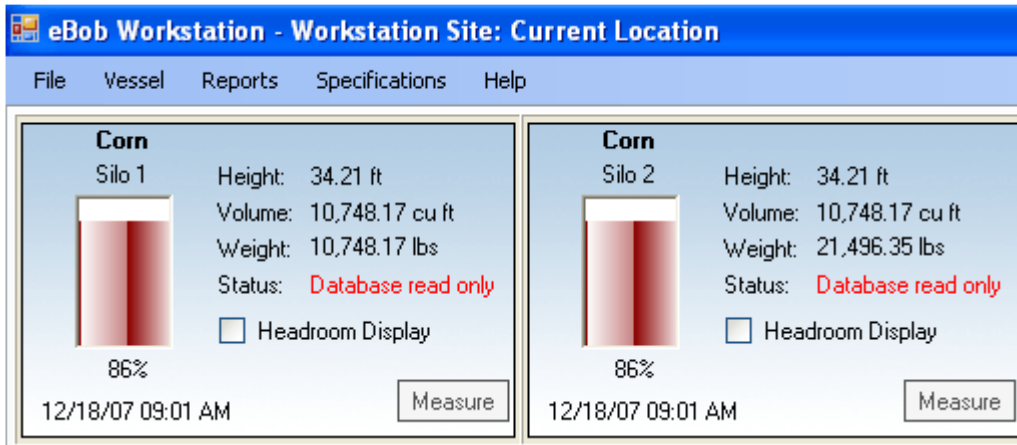

Figure 55

6.2.0 Creating a remote eBob Controller Connection

Note: An eBob remote Controller installation requires that another eBob Controller PC has been setup, with a SmartBob sensor network, and is available on the LAN or WAN.

Reference Figure 47.

An eBob V5 Remote Controller installation essentially connects the user interface of eBob V5 installed on one PC to the SQL Database and eBob V5 Measurement Engine and Scheduler services on another PC.

Note: The Windows Services connection via TCP/IP allows the remote PC to control the SmartBob sensors on another PC.

For an eBob Controller or Host connection, SQL Express must be configured on the host or controller PC to allow remote connection via the TCP/IP network so the remote controller install can connect to the eBob SQL database. To allow remote connection to a SQL database on the controller PC:

Go to Start | Program | Microsoft SQL Server 2005 | Configuration Tools | SQL Server Surface Area Configuration.

On the next screen, select “Surface Area Configuration for Services and Connections” and then select “Remote Connections”, shown in the navigation panel (Figure 56). Check local and remote connection and select TCP/IP or Named connection depending on your network configuration.

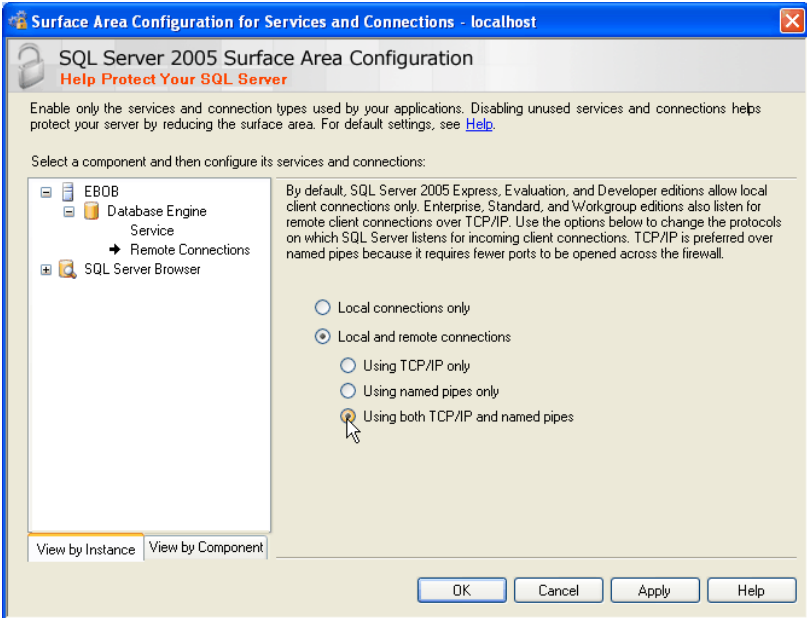

Figure 56

6.2.1 Installing eBob V5 as a Remote Controller

Start the install process by navigating to the root of the eBob Distribution CD and clicking “setup.exe” or open Control Panel | Add or Remove Programs | Add New Program, then choose CD or Floppy, browse to the root of the distribution CD and select “setup.exe”.

After agreeing to the EULA, the installation package will display a selection box with Easy or Advanced installations. Select Advanced Installation.

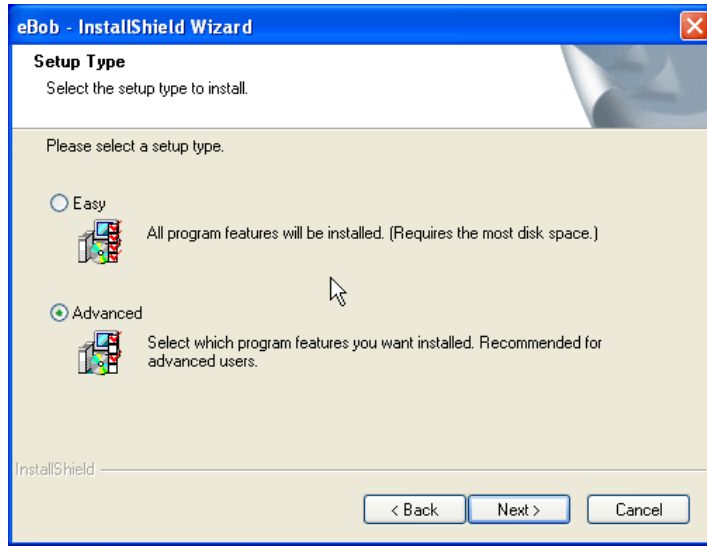

Figure 57

The next screen (Figure 58) will ask you to select which eBob component to install: the eBob Workstation application (User Interface), SQL Express and the eBob SQL database, or the Measurement Engine and Scheduler services. Select “Application” as shown in Figure 58

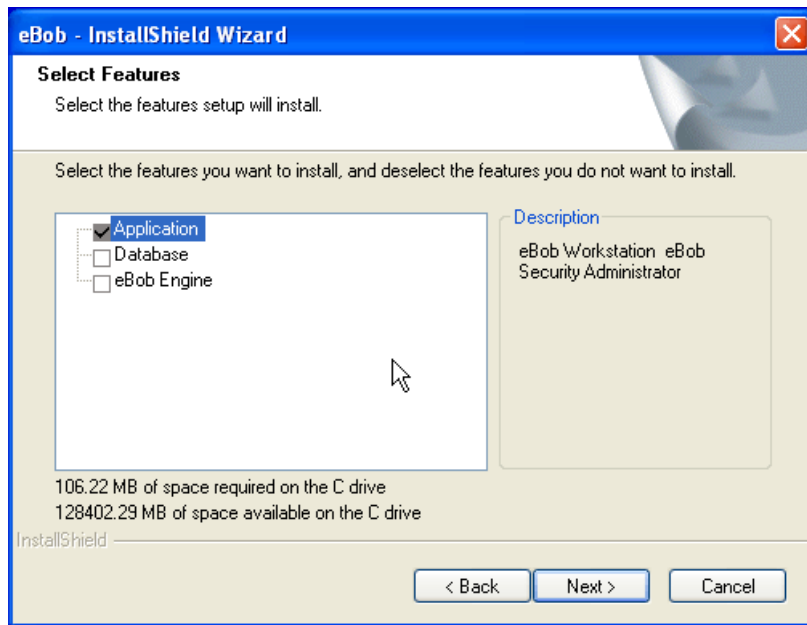

Figure 58

The next screen will ask you where to install the eBob Application. The default path is C:\Program Files\ eBob and is the recommended installation path.

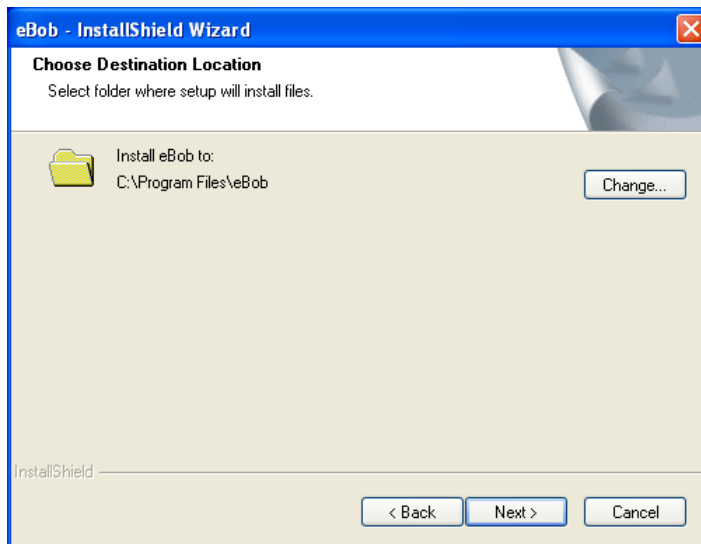

Figure 59

The installer will then complete the installation of the eBob Workstation application. The final step is to connect the eBob user interface to the database and the eBob Engine and Scheduler Services.

6.2.2 Connecting to the Host PC

6.2.3 Connecting eBob Controller to a remote SQL database

Go to Start | Program | eBob | eBob Security Administrator. Highlight “eBob Workstation” in the selection list and then Select.

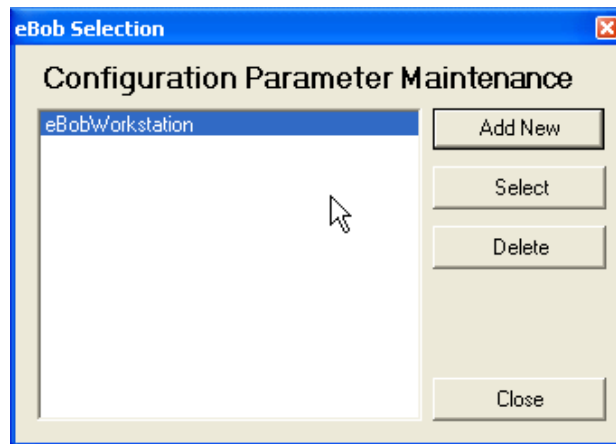

Figure 60

On the parameters configuration screen Data Source field, enter the [machine name or IP address] \ eBob of the connection to the remote database.

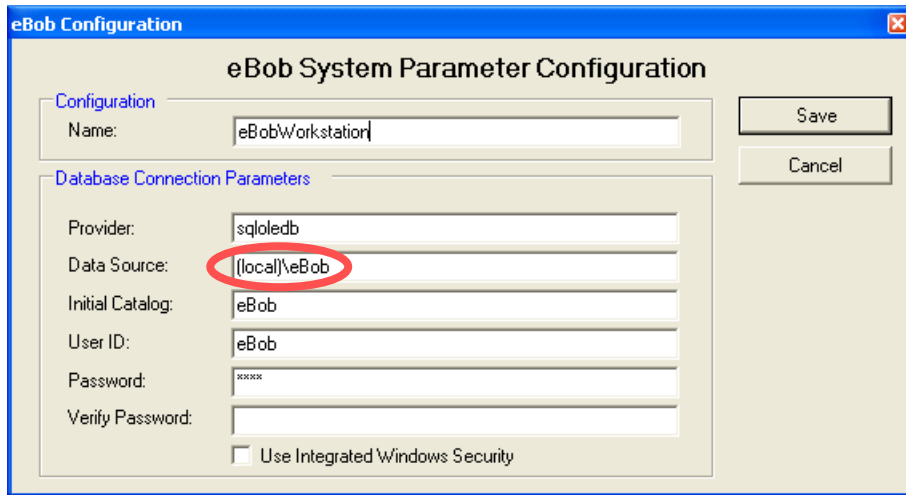

Figure 61

Note: The default SQL User ID and password are “eBob” and “eBob” (case sensitive) respectively and the correct password will need to be entered in the Verify Password entry box to Save any changes.

6.2.3 Connecting eBob Controller to the remote Measurement Engine and Scheduler Services

Using Windows Explorer, navigate to the Program Files | eBob folder on your PC. Open the file “eBobWorkstation.exe.config” as shown below.

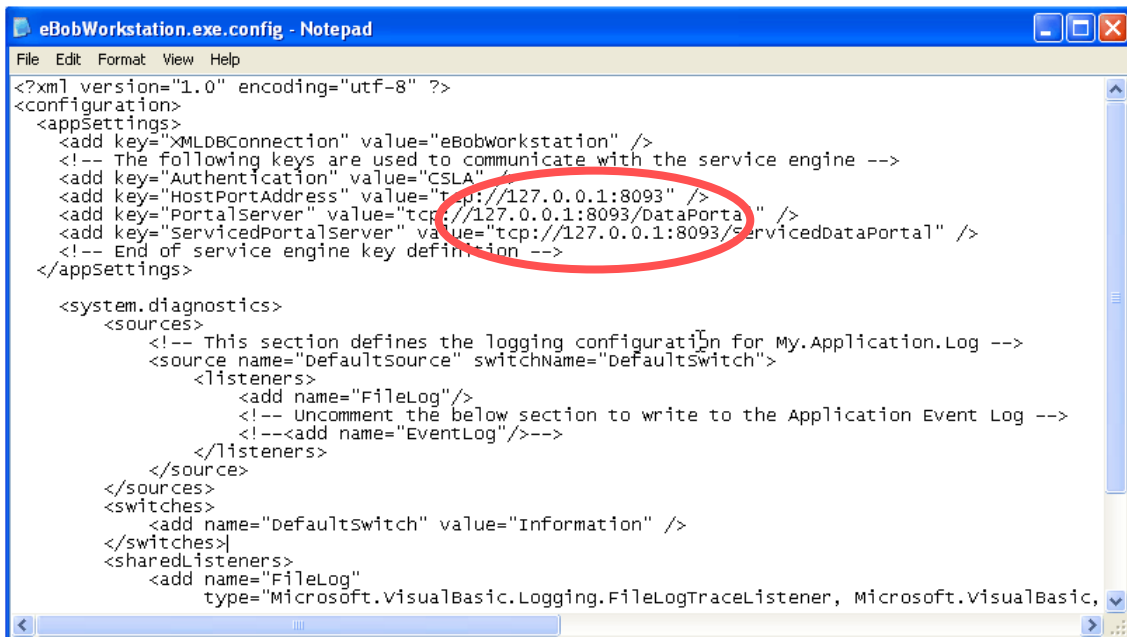

Figure 62

Modify the TCP/IP addresses circled above to an IP address supported by your LAN that will allow the eBob V5 User Interface to connect to the services on the “Host” eBob V5 PC and save the file.

***Note:** Modify the TCP/IP address only, not the port settings or the text following the IP address.*

When the eBob Workstation user interface is started on the remote PC it will connect to the remote host eBob SQL Database and Measurement Engine service on the remote PC via the TCP/IP connection parameters in the modified configuration files.

Once connected, the remote eBob V5 user interface will be able to configure, measure and report just as the “Host” that is installed on the PC connected to the SmartBob sensors.

7.0 Tips and Troubleshooting

7.1 USB to Serial port adapters

If using a USB to Serial Port adapter to connect to the SmartBob2 remotes, please note the following setup parameters:

- Install the correct device driver as per the adapter manufacturer's instructions.
- Use Device Manager to verify the COM port number assigned by the USB host.
- This COM port number must be enter in the Workstation Site Setup Communications Port field.

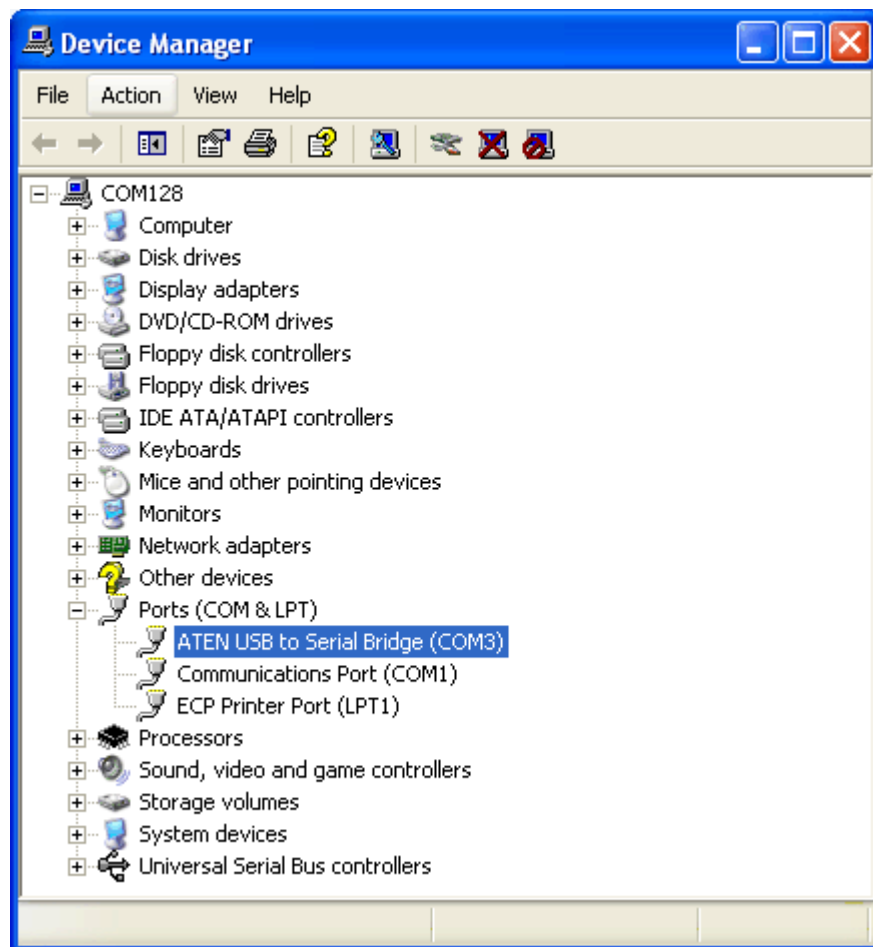

Figure 63

7.2 Restarting the Measurement and Scheduler Services

If an automated measurement schedule stops taking scheduled measurements as expected, and the configuration of the Scheduler appears correct as per Section XX, it is possible a windows update or other system event has disconnected the Scheduler or Measurement services from the SQL database and user interface.

To force the services to re-establish a connection, use the Services Management tool in windows to restart each of the eBob services.

Right click on My Computer and then select Manage in the drop down list. This will bring up the Computer Management screen. Click on Services and Applications then Services to bring up a list of the Windows Services that are currently running on the PC.

Right click on both the eBob Engine service and eBob Scheduler and select restart. This will restart the service applications and reconnect to the database. If the

Note: Close and reopen the eBob V5 User Interface after the services have been restarted.

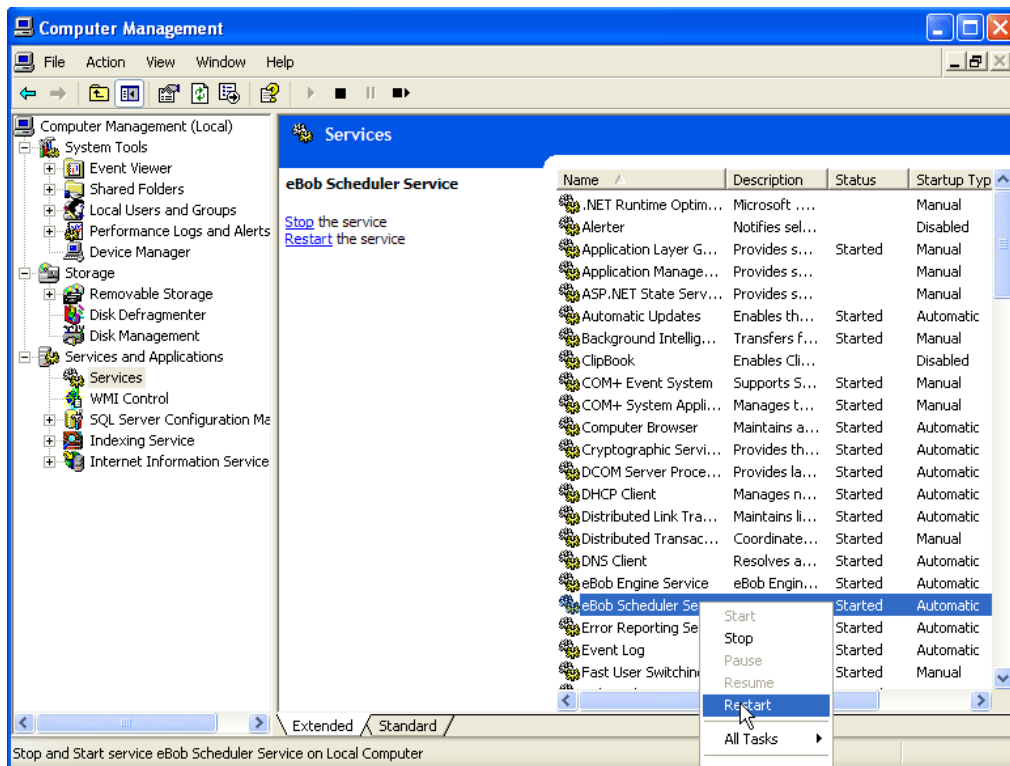

Figure 64

7.4 Upgrade from IMS 2.2.3 considerations

PC System Requirements:

PC with 1GHz or higher, Intel® Pentium® Processor or compatible
Microsoft® Windows XP Professional or Vista Business Edition
Microsoft® .NET framework 2.0
256 MB of RAM minimum
40MB of available hard-disk space
1 Serial communications port
RS-485 Interface Module (supplied by BinMaster)
RS-232 Serial Cable (supplied with interface module)
SmartBob Remote Units

SmartBob Remotes

The eBob Software requires that the Smart Bob2 Remote communications protocol is in setting “A”, which is implemented by a hardware jumper on the PCB. IMS 2.2.3 used setting “B”. See Figure 57 below for jumper location or contact BinMaster Technical Support.

The firmware revision for the microprocessor must be Revision 2.3 or greater. See Figure 65 below for microprocessor location or contact BinMaster Technical Support.

SBC Console

If an SBC console is being used in the system, the change to communications protocol “A” requires the SBC Console be replaced with an SBC-A Console to be compatible with eBob Software.

System Transfer

IMS 2.2.3 may be left installed in the computer until transfer to eBob 5.0 is complete and tested, but the IMS 2.2.3 will NOT be able to run the system because of the change in communications protocol.

It is recommended that users take detailed notes as to the vessel parameters before installing eBob 5.0. This will also allow you to setup the new system consistent with the old system.

7.5 Upgrade from eBob V4 considerations

PC System Requirements:

PC with 1GHz or higher, Intel® Pentium® Processor or compatible
Microsoft® Windows XP Professional or Vista Business Edition
Microsoft® .NET framework 2.0
256 MB of RAM minimum
40MB of available hard-disk space
1 Serial communications port
RS-485 Interface Module (supplied by BinMaster)
RS-232 Serial Cable (supplied with interface module)
SmartBob Remote Units

SmartBob Remotes

The eBob Software requires the Smart Bob2 Remote communications protocol is in setting “A”, which is implemented by a hardware jumper on the PCB (Figure 65).

The firmware revision for the microprocessor must be Revision 2.3 or greater. See Figure 65 below for microprocessor location or contact BinMaster Technical Support.

System Transfer

eBob V4 may be left installed in the computer until transfer to eBob 5.0 is complete and tested. It is recommended that users take detailed notes as to the vessel parameters before installing eBob 5.0. This will also allow you to setup the new system consistent with the old system.