

Take-Up Frames and Assemblies

Available in seven different styles to suit your specific needs: Slide Tube™, Top Angle, Center Pull, Heavy Duty Top Mount, Light Duty Top Mount, Wide Slot Side Mount and Scissors Pivot Gravity Take-Up Assembly.

Douglas take-up frames utilize many common styles of bearings from most major bearing manufacturers¹.

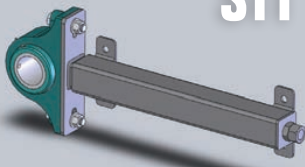
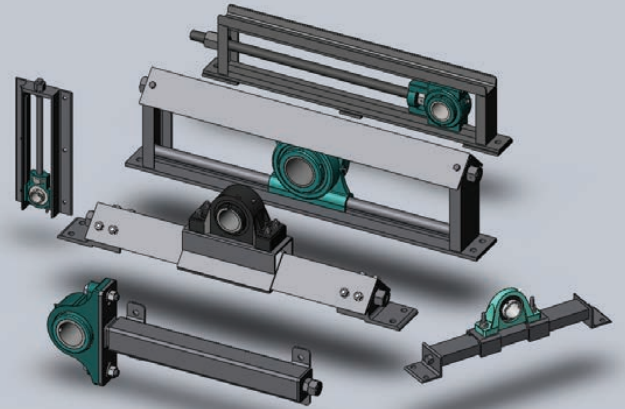

STT

STT – The Slide Tube™ is a low cost ball or roller bearing take-up frame that is tough and dependable. The space saving design eliminates the need for additional take-up supports and allows for even load distribution.

TAF – The Top Angle is a traditional style take-up frame. The bolted top angle protects the threaded rod and allows for relatively simple bearing removal and replacement. Available with an optional channel or round bar bottom piece to accommodate SKF and Linkbelt or Dodge bearings respectively.

CPT – The Center Pull is a traditional style take-up frame suitable to a wide variety of applications. The location of the threaded rod, in the center of the frame and bearing, helps to ensure even tensioning during operation.

HDT – The Heavy Duty Top Mount is a traditional style take-up frame that is designed for severe applications. The single piece heavy mounting plate is designed for a four bolt pattern style bearing but can be manufactured for two bolt bearings. The extra heavy welded steel construction helps ensure long-life and dependability in the roughest applications.

LDT – The Light Duty Top Mount is a low cost frame with a two piece saddle design that is adjustable and can accommodate a wide range of 2 bolt pillow block ball bearings.

WST – The Wide Slot Side Mount is a low cost frame that is designed to fit in very tight spaces. It mounts on the side of a conveyor frame or chute and uses wide slot ball bearings.

STU – The Scissors Pivot® Gravity Take-Up is an engineered take-up system that incorporates a standard assembly consisting of 3 pulley assemblies, a lever arm and support chains (not shown). It automatically adjusts for belt stretch and is engineered for proper belt tension.

ACME™ all thread rod standard.

¹Bearings are provided separately.

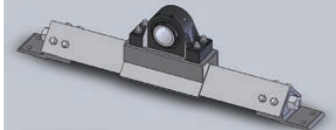

HDT

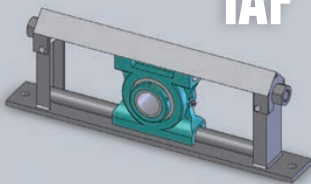

TAF

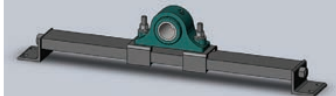

LDT

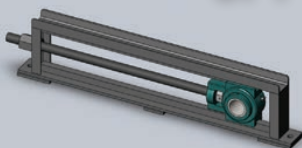

CPT

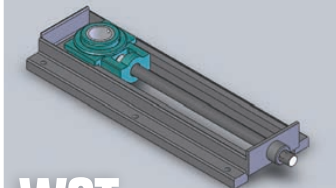

WST

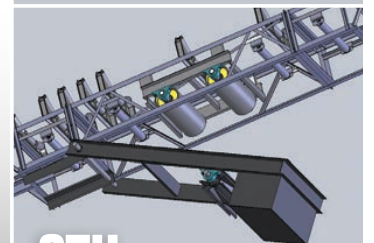

STU

DOUGLAS D®